

14  
mm

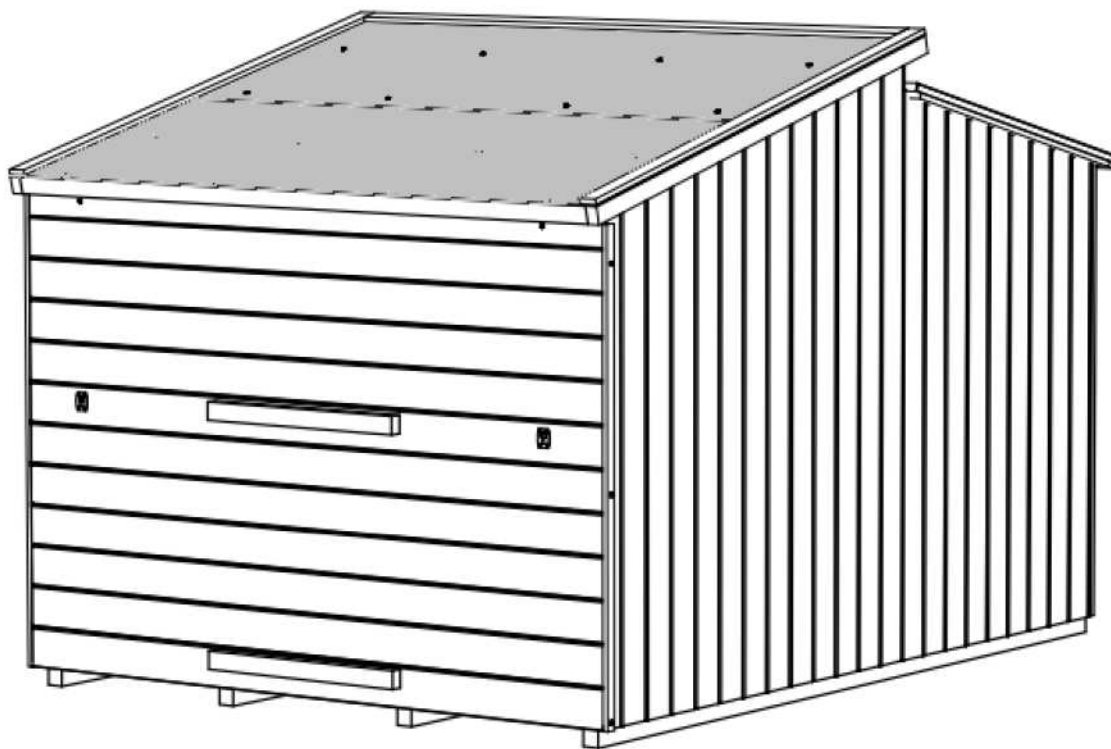

PROD.Nr.:



1415

Gartenpro Kft.  
9444 Fertőszentmiklós  
Soproni úti ipartelep  
HUNGARY  
16  
1415-CPR-43-(C-80/2015)  
ETA-15/0873  
ETAG 007







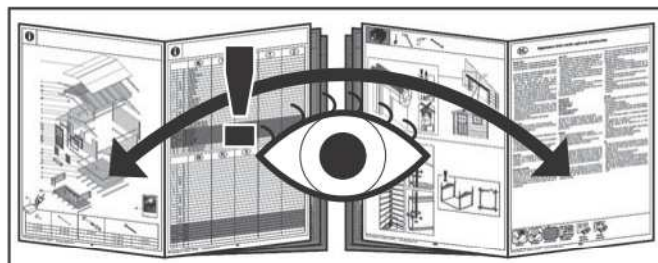

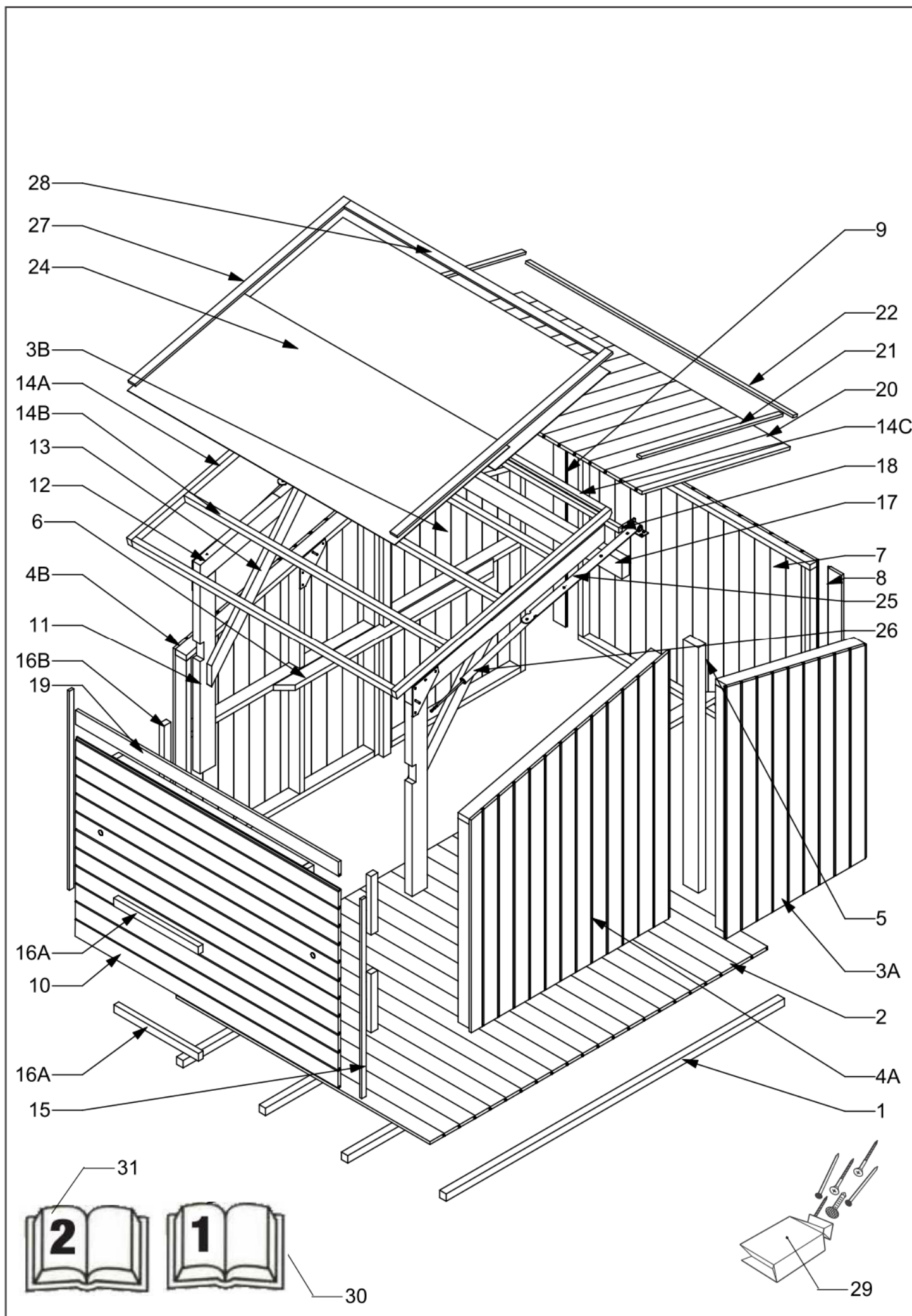







BIKE BOX\_2 1520 F1R1B0  
Art.Nr. G460045N  
Ean.Nr.5999553064933

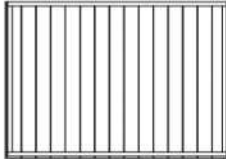

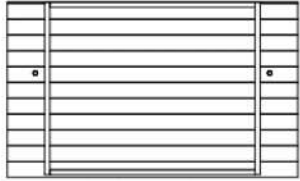















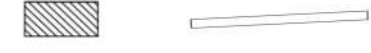

Hout voor Outdoor Life Products blokhutten en tuinhuizen is vooral afkomstig uit gecertificeerde en goed beheerde bossen.  
Wood used for our Outdoor Life Products cabins and garden houses is mostly sourced from certified and well-managed forests.  
Das Holz für Outdoor Life Products Blockbohlenhäuser und Gartenhäuser wird größtenteils aus zertifizierten Wäldern bezogen.  
Les bois pour chalets et maisons de jardin de Outdoor Life Products proviennent en grande partie de forêts certifiées et gérées durablement.





1	G2227224		38x38x998mm	8X
2.	G2222836		15x99x1500mm	22X
3A.	G2227318		826x1290mm	1X
3B.	G2227319		826x1290mm	1X
4A	G2227320		1172x1370mm	1X
4B	G2227321		1172x1370mm	1X
5.	G2227282		43x90x1242mm	2X
6.	G2227338		28x65x1300mm	2X
7.	G2227317		1370x1082mm	1X
8.	G2227334-F		13,5x78x1082mm	1X
9.	G2227334-N		13,5x78x1082mm	1X
10.	G2227322		1554x1018mm	1X
11.	G2227323		43x90x1000mm	2X
12.	G2227324		43x90x1192mm	2X
13.	G2227336		28x65x1000mm	2X
14A	G2227063-1310		28x40x1310mm	2X
14B	G2227063-1535		28x40x1535mm	4X

14C	G2221304-1535		20,6x27,6x1535mm	1X
15.	G60147540-1060		12x26x1060mm	2X
16A	G2227063-500		27,6x40x500mm	2X
16B	G2227063-300		27,6x40x300mm	4X
17.	G2227333		43x90x1500mm	1X
18.	G2221304-1370		20,6x27,6x1370mm	1X
19.	G2227335		13,5x75x1554mm	1X
20.	G2227281		15x99x900mm	18X
21.	G60147540-860		12x26x860mm	2X
22.	G60147540-1580		12x26x1580mm	1X
23.	G2227339		1000x1650mm	1X
24.	G545017		700x1580mm	2X
25.	G60681859		44x700mm	2X
26.	G101502		28x1100mm 400N	2X
27.	G2222996		12x42x1356mm	2X
28.	G2222949		12x42x1510mm	1X
29.	G7061192		Kell.cs.BIKEBOX	1X
30.	G6099908	 Building instr.	Útm. Építési	1X
31.	G6065190	 General Conditions	Útm. Általános	1X

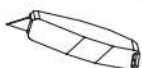
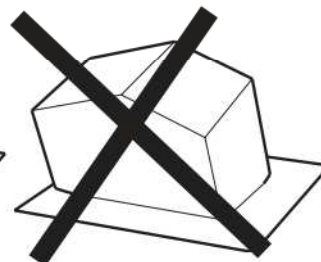
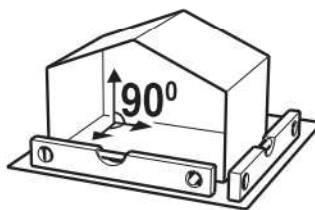
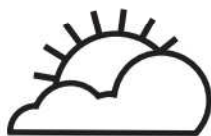
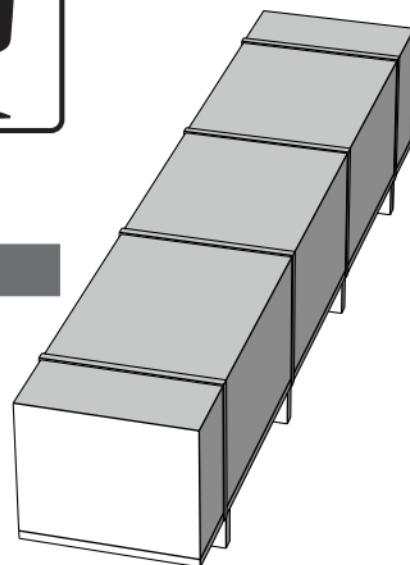
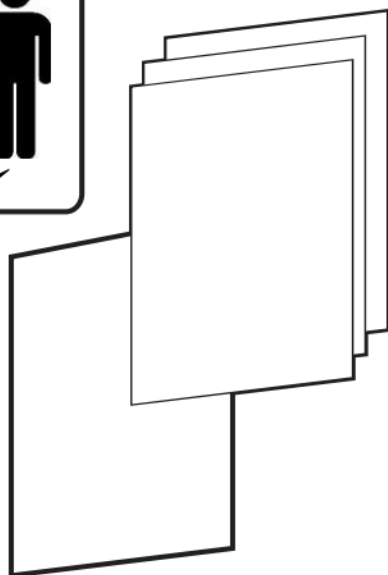
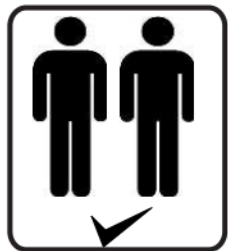
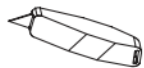
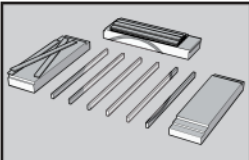

M10

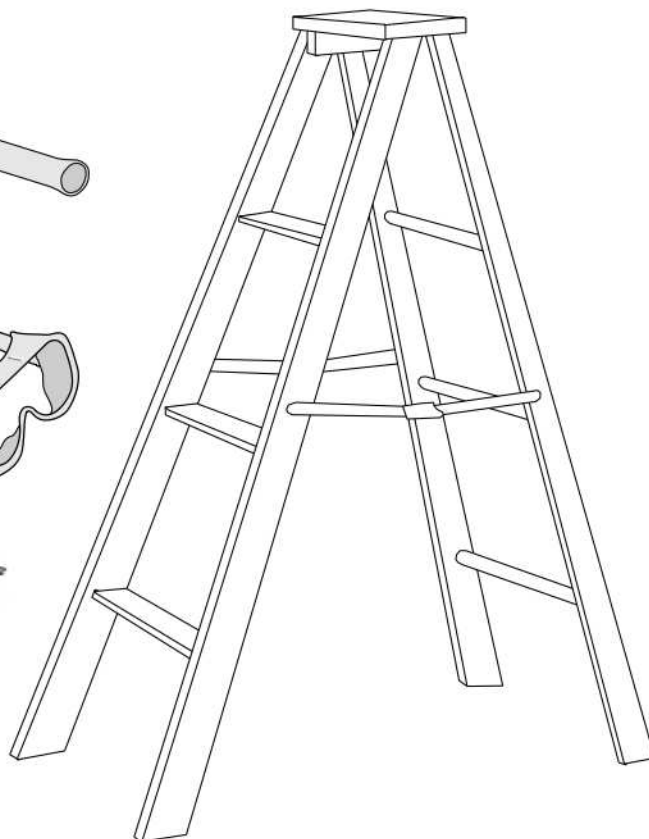
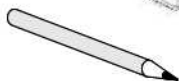
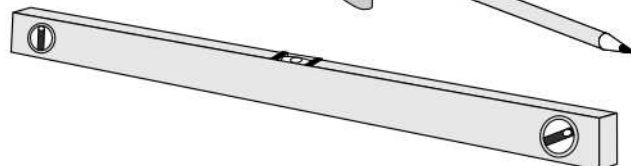
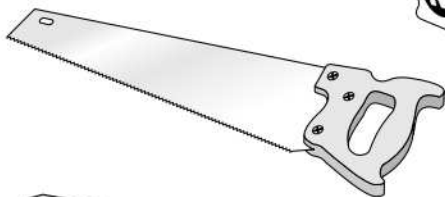
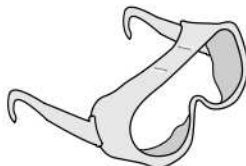
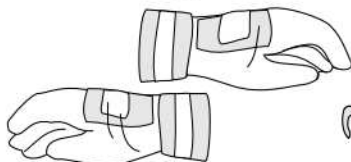
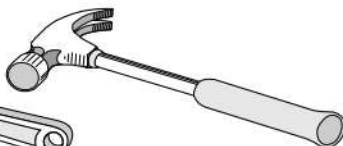

1

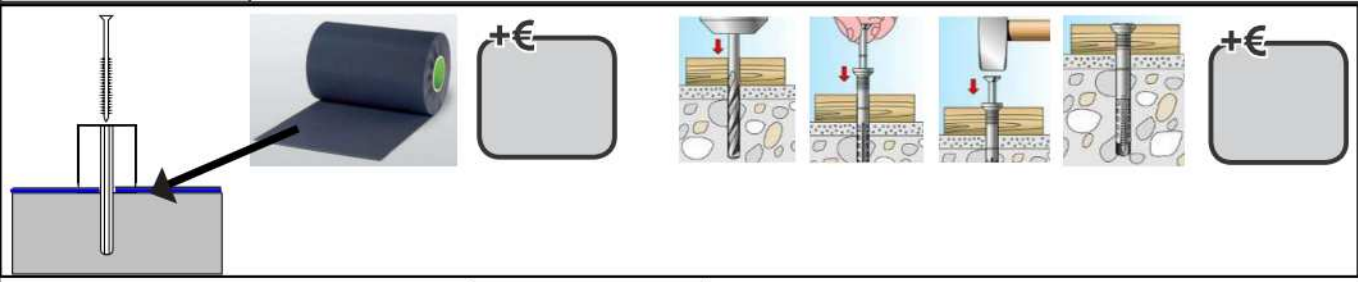
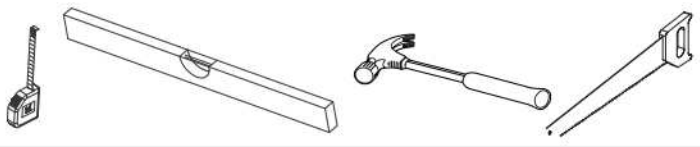

POS

- 1 38x38x998 8X
- 2 15x99x1500 22X

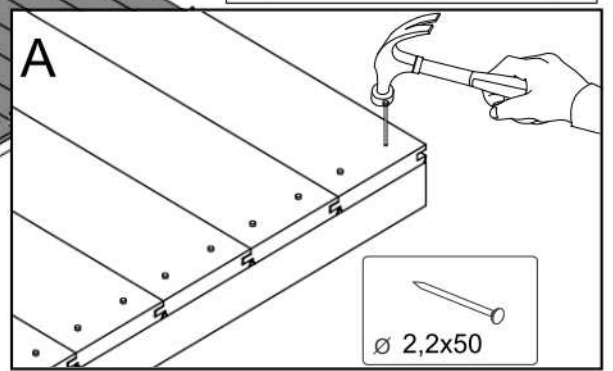
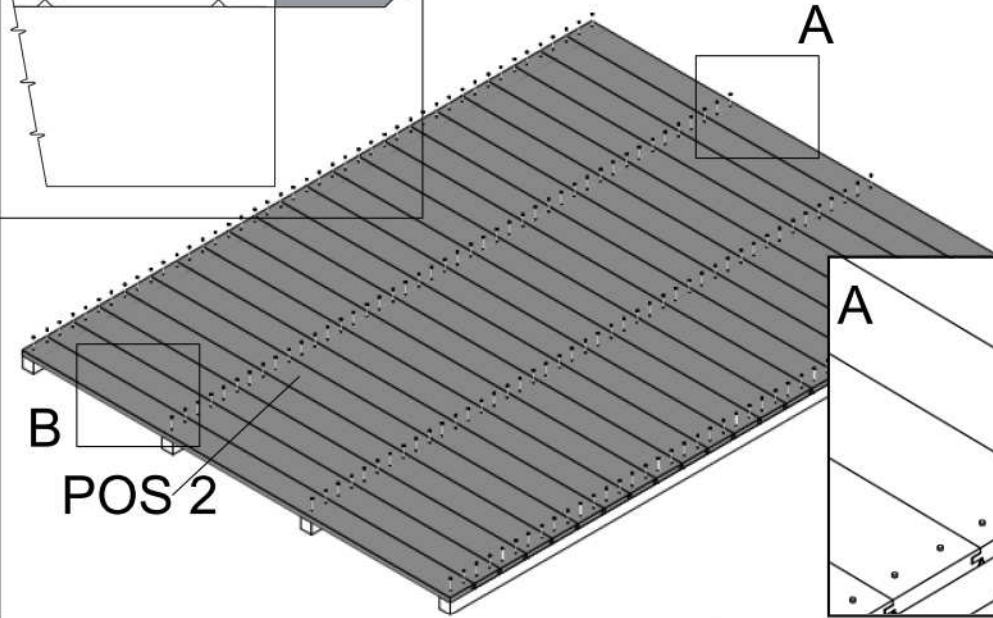
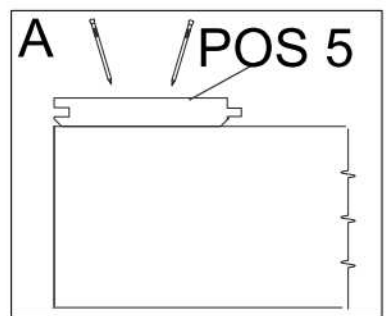
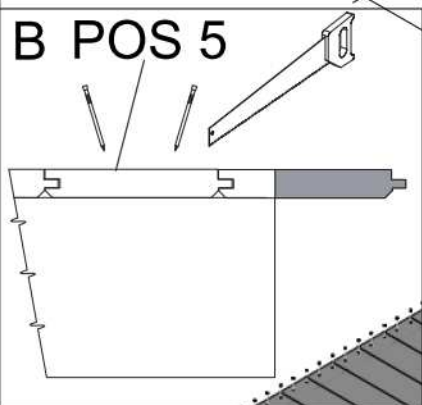
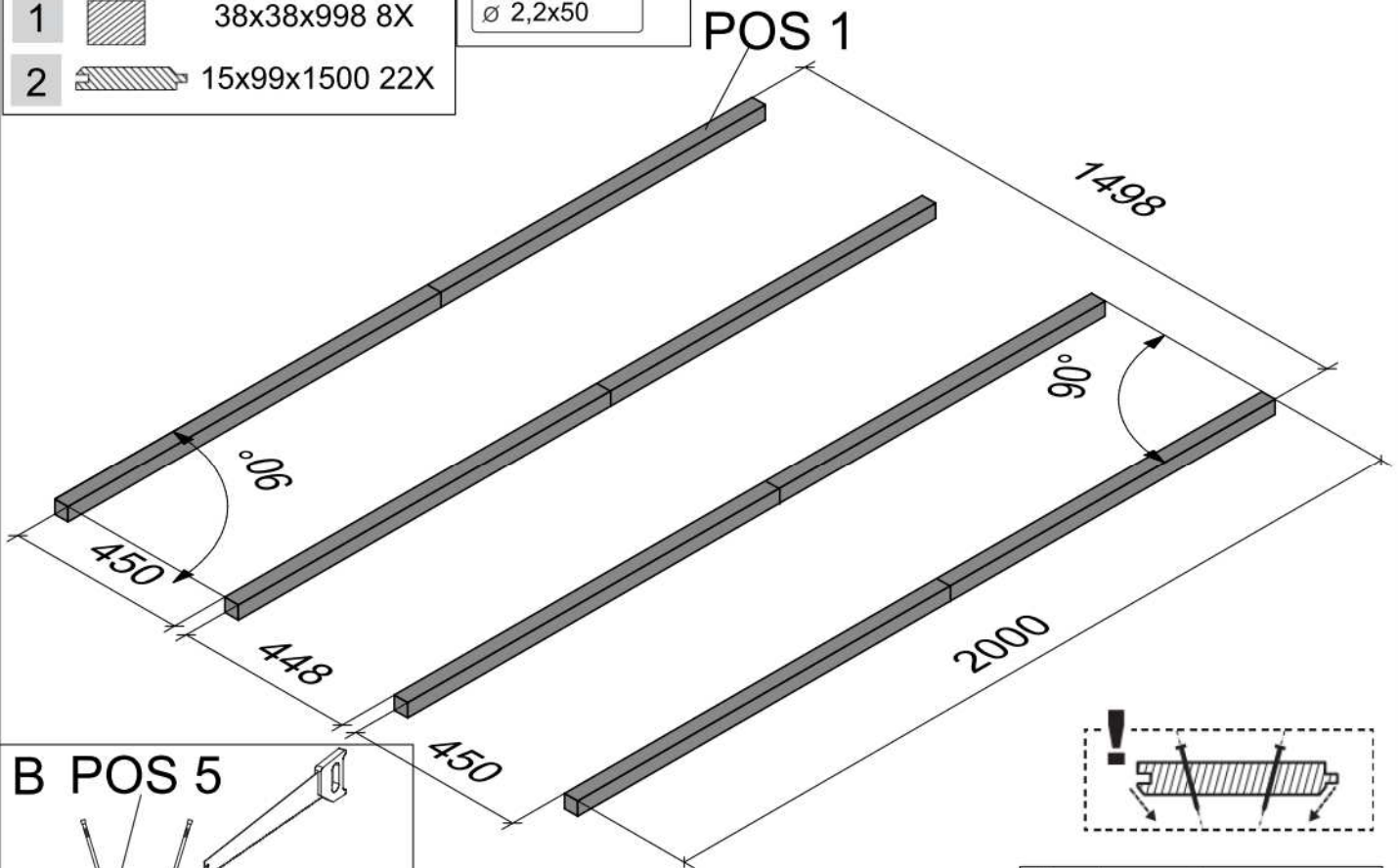
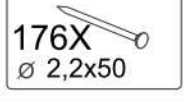

2

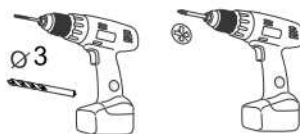
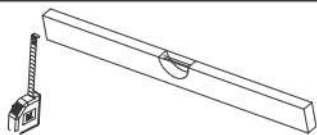

POS

3B



826x1290 1X

4B



1370x1172 1X

26X

4x60mm

7

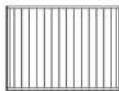

1370x1080 1X

4A



1370x1172 1X

3A



826x1290 1X

5



43x90x1242 2X

POS3B

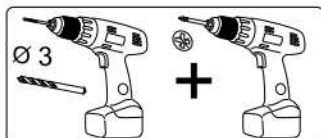
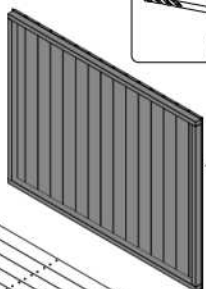

POS7

4X

4x60mm

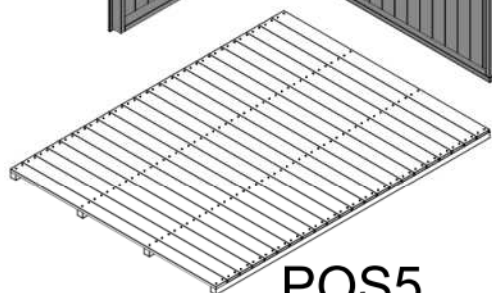
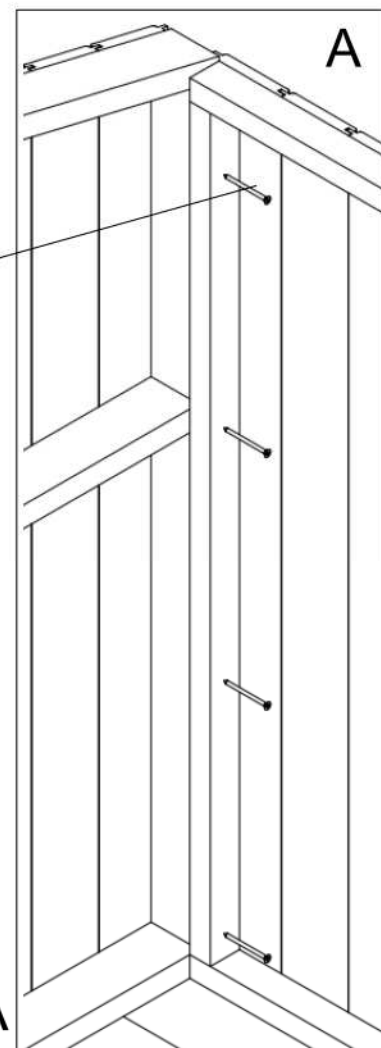

POS5

A

POS4B

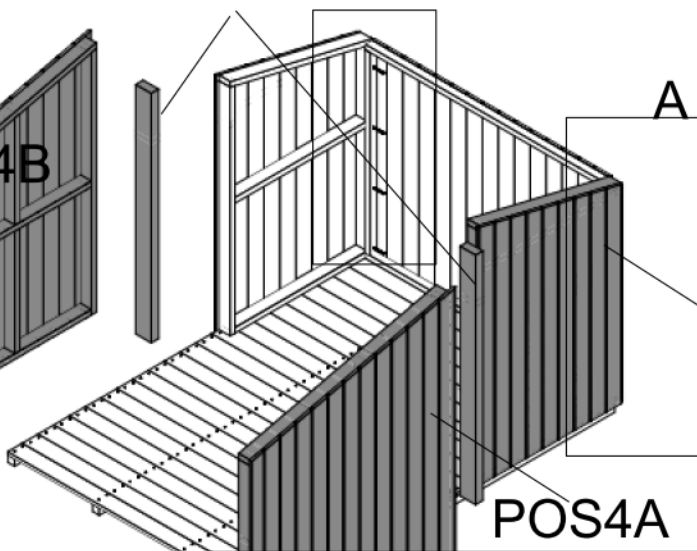

POS4A

POS3A

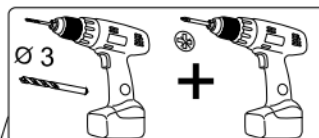

14X

4x60mm

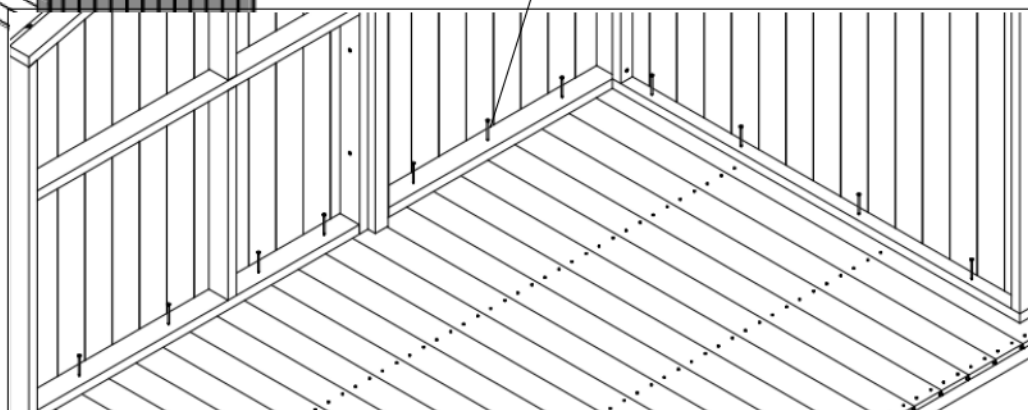

3

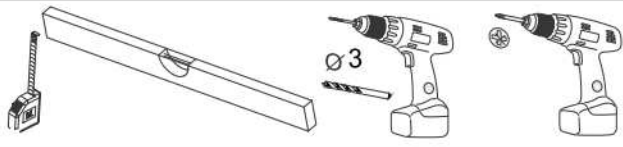

POS

- 8 13,5x78x1082 1X
- 9 13,5x78x1082 1X
- 17 43x90x1500 1X
- 18 20,6x27,6x1370 1X

- X16 3,5x35mm
- 24X 4x60mm
- 2X 150x150mm

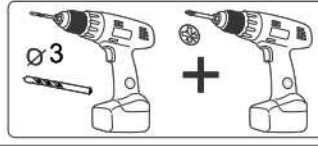
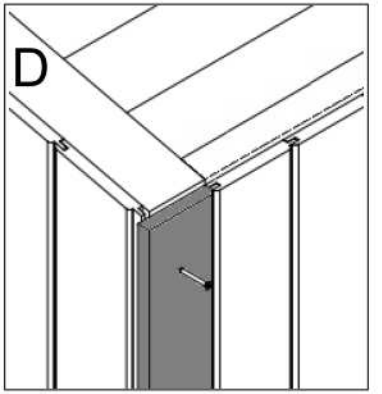
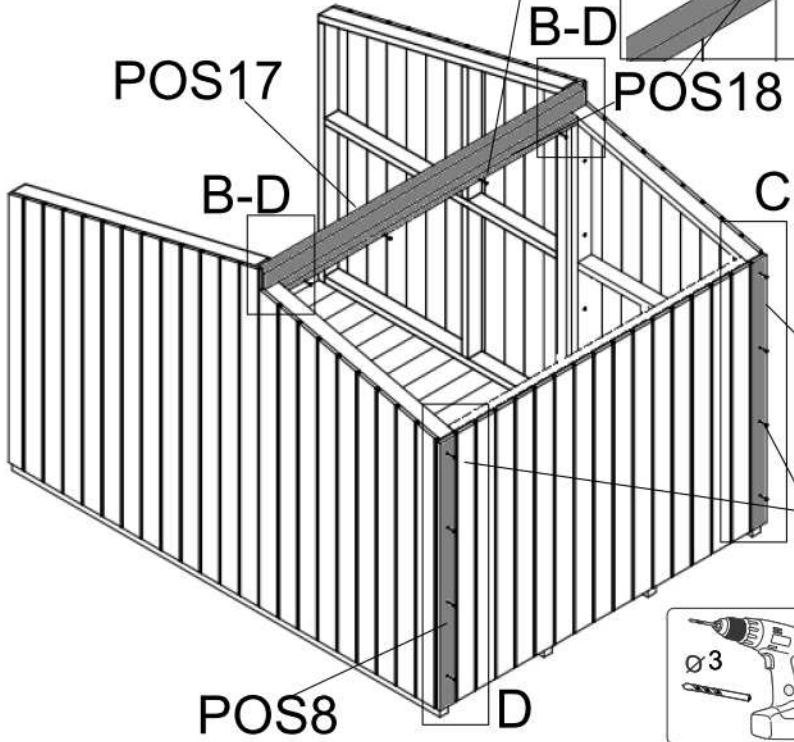
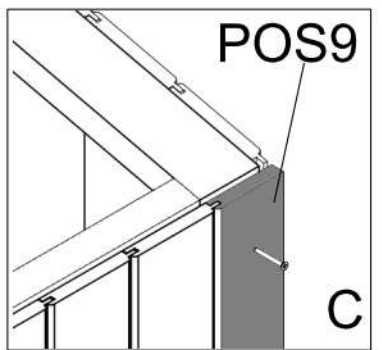
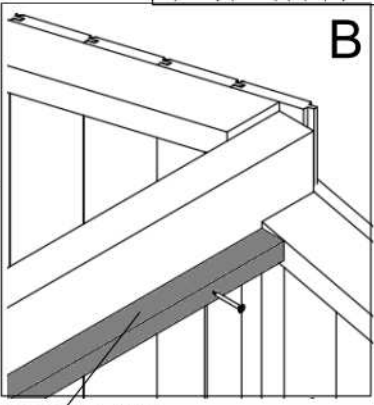
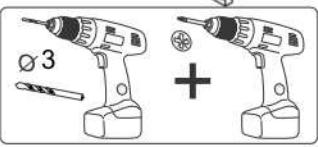
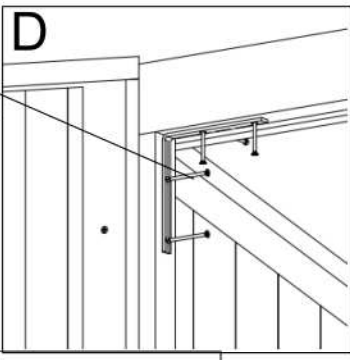
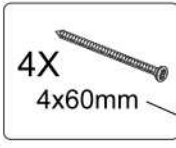
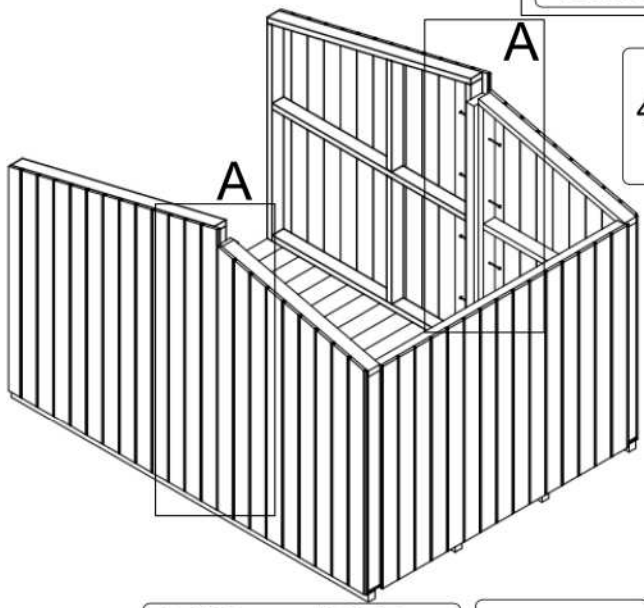
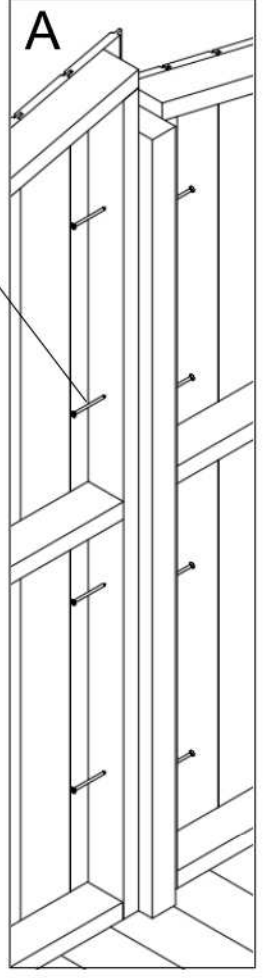
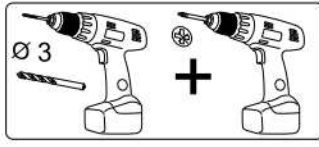
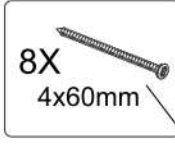
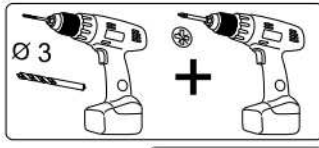



4

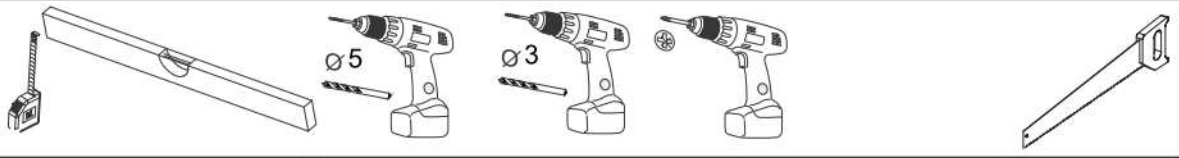

POS

20 15x99x900 18X

X2  
6x120mm

2X  
4x60mm

X72  
3,5x35mm

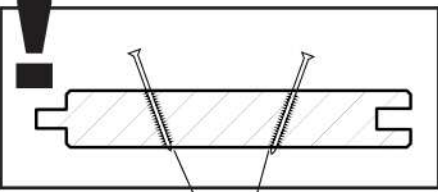
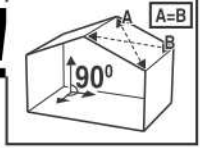

Ø 3  
X2  
3,5x35mm

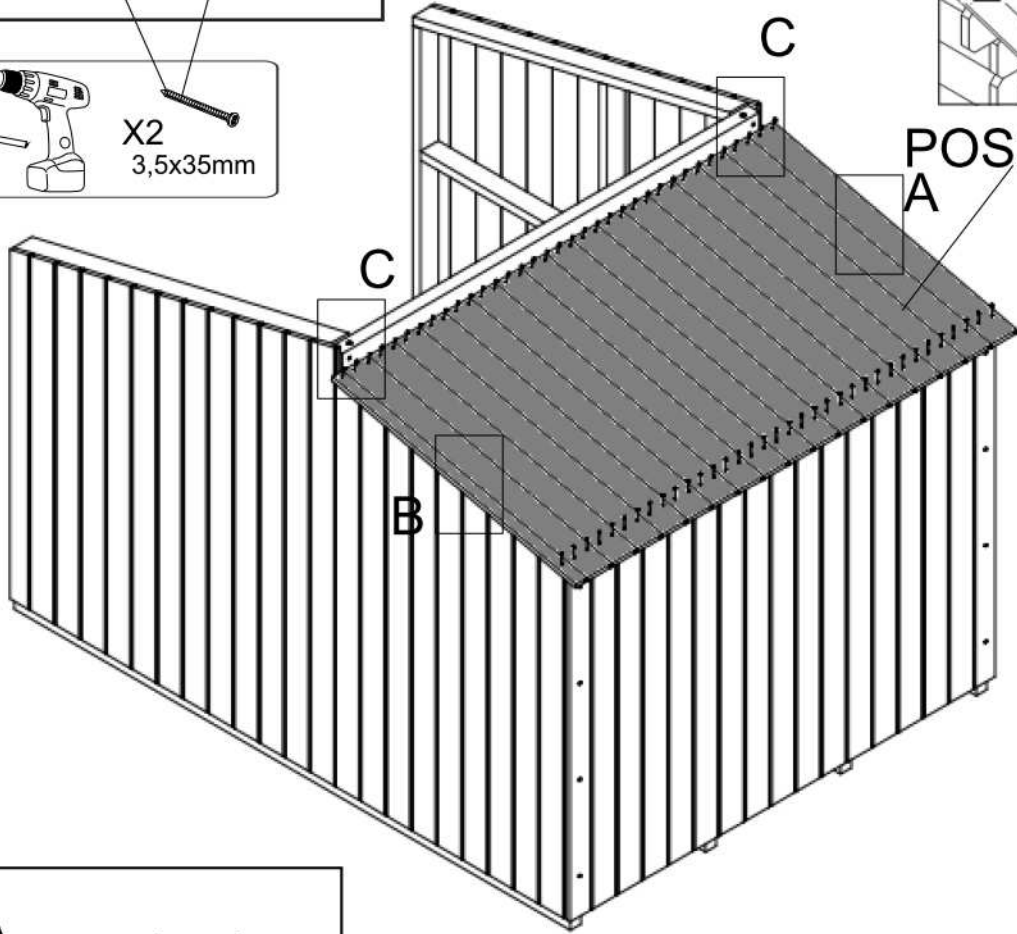
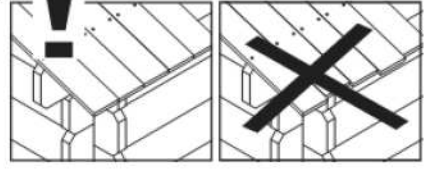

Ø 5 +

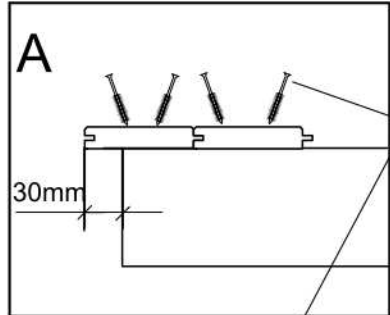

X2  
3,5x35mm

Ø 3 +

X2  
6x120mm

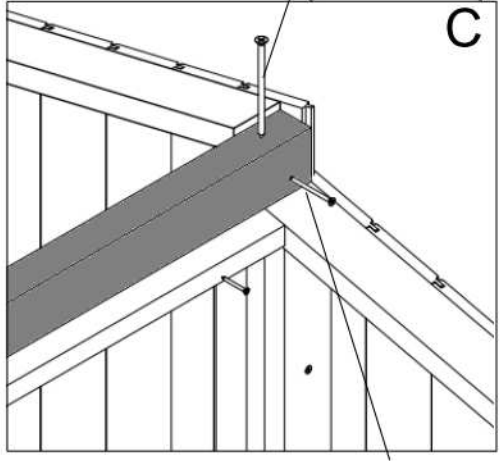
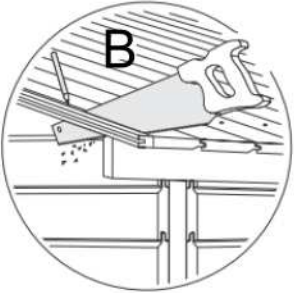
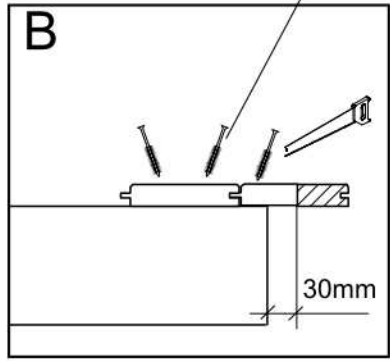

Ø 3 +

2X  
4x60mm

**5**

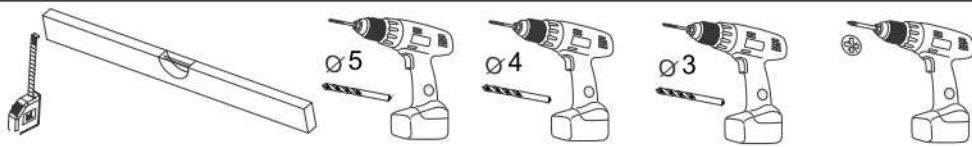

**POS**

21  12x26x860 2X

22  12x26x1580 1X

23  1000x1650 1X

 X12  
3,5x25mm

 12X  
Ø 2x16

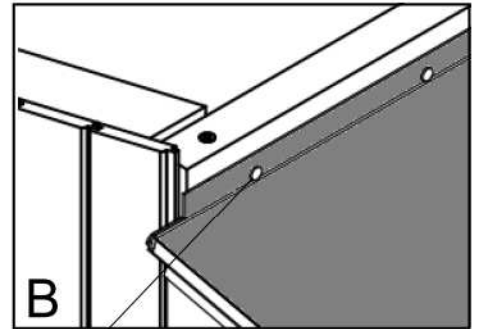
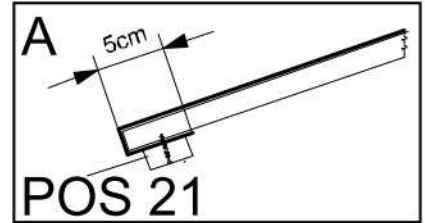
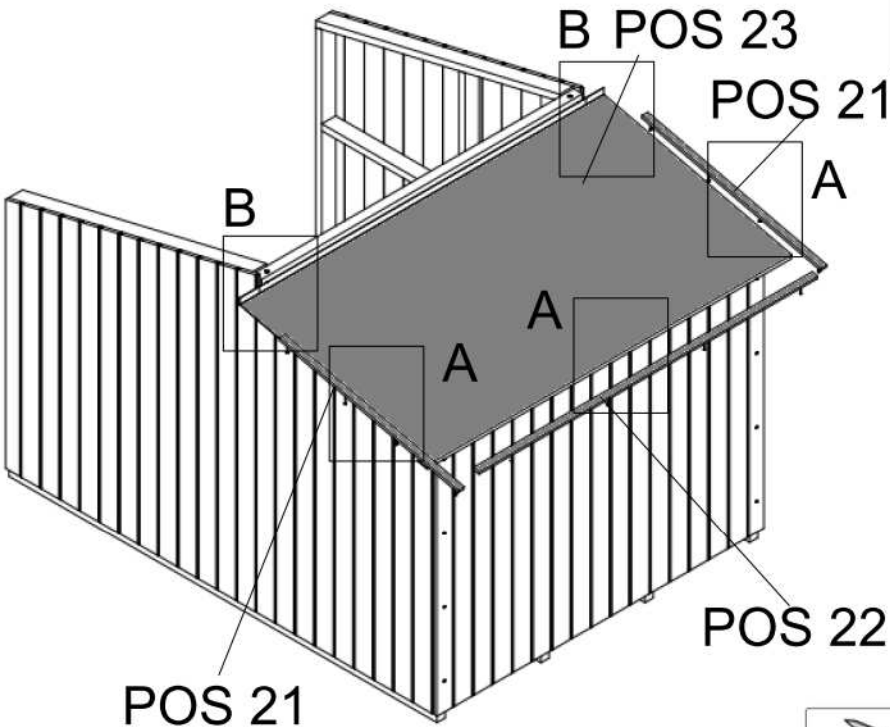
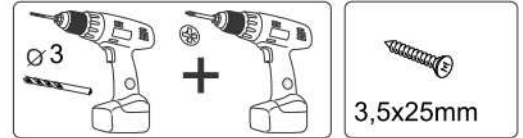
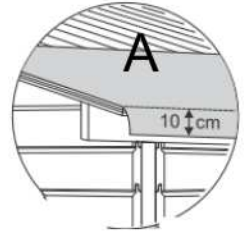



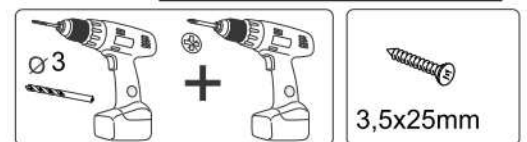
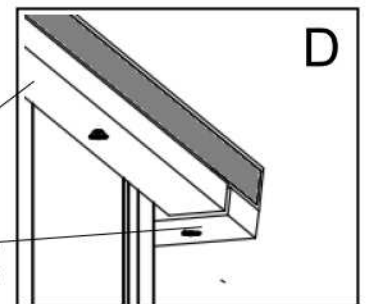
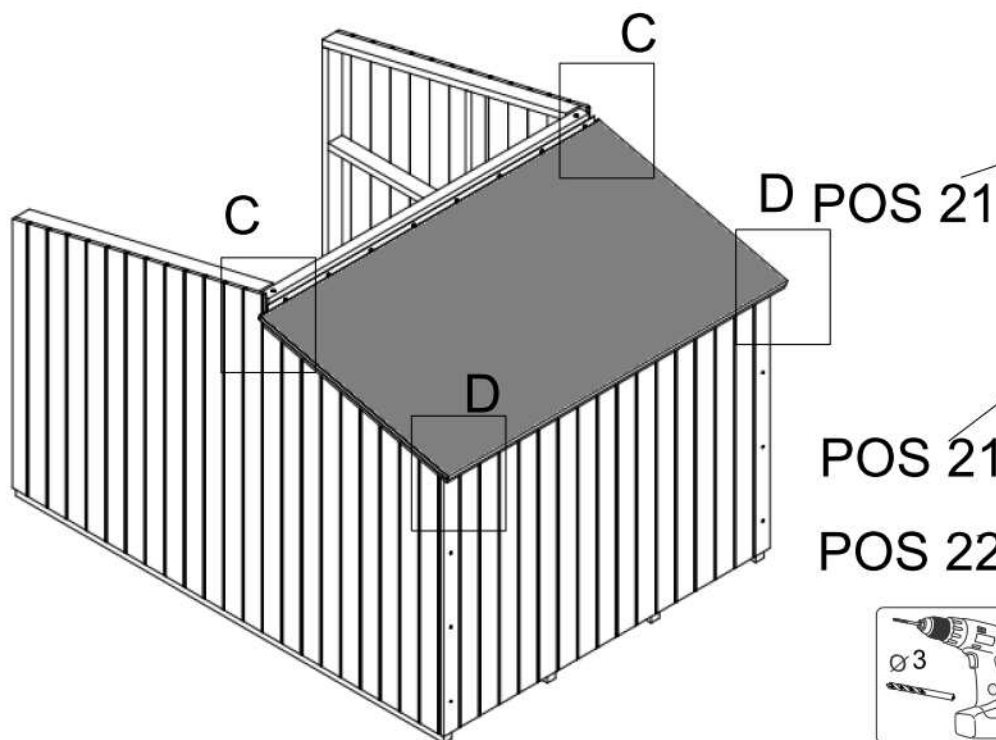
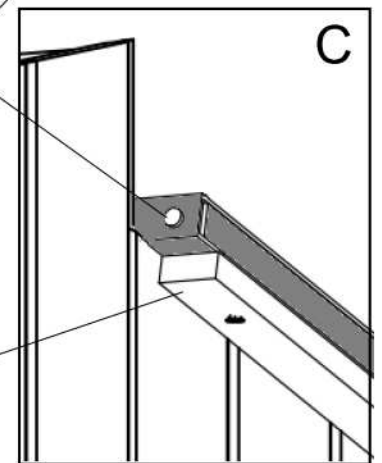

 Ø 2x16

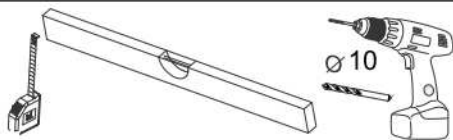

6



POS

- |     |   |                  |
|-----|---|------------------|
| 10  |  | 1554x1018 1X     |
| 11  |  | 43x90x1000 2X    |
| 12  |  | 43x90x1192 2X    |
| 13  |  | 43x90x1000 2X    |
| 16B |  | 20,6x27,6x300 4X |

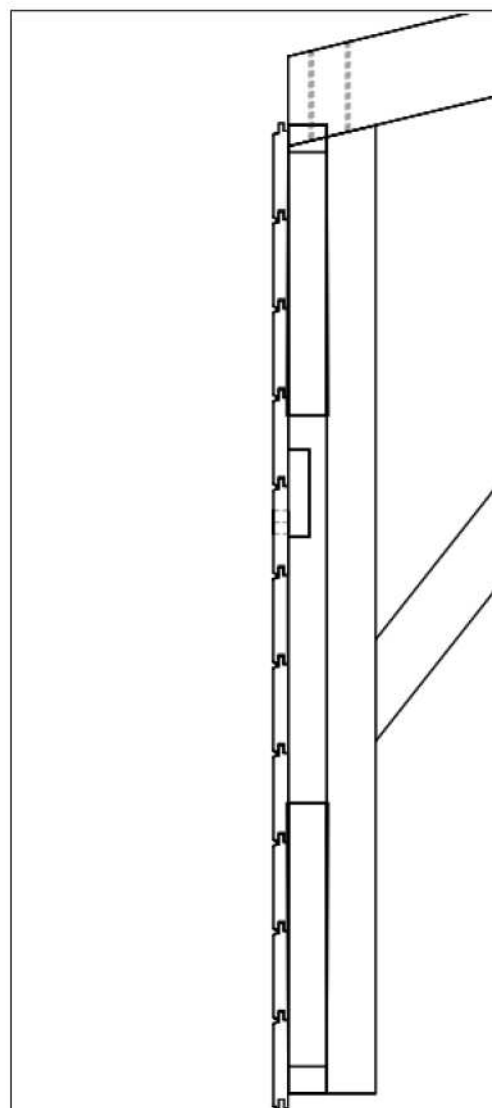
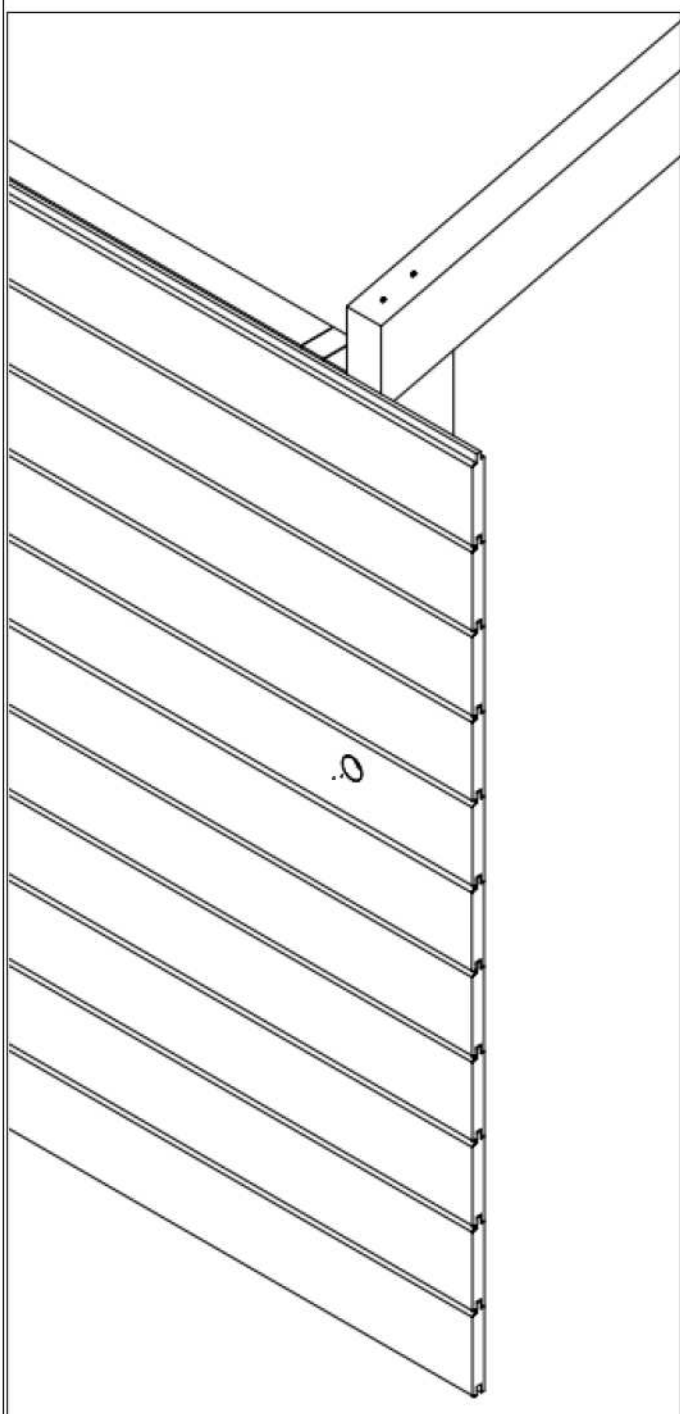

7

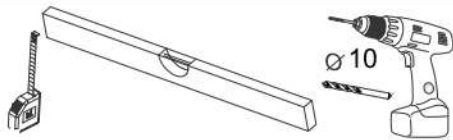

2X

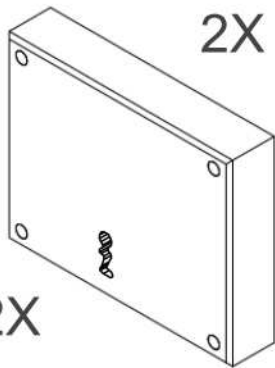

2X



2,5x12mm

6X



3,5x35mm

8X

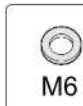

M6

8X

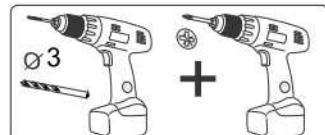

Ø3



+



3,5x35mm

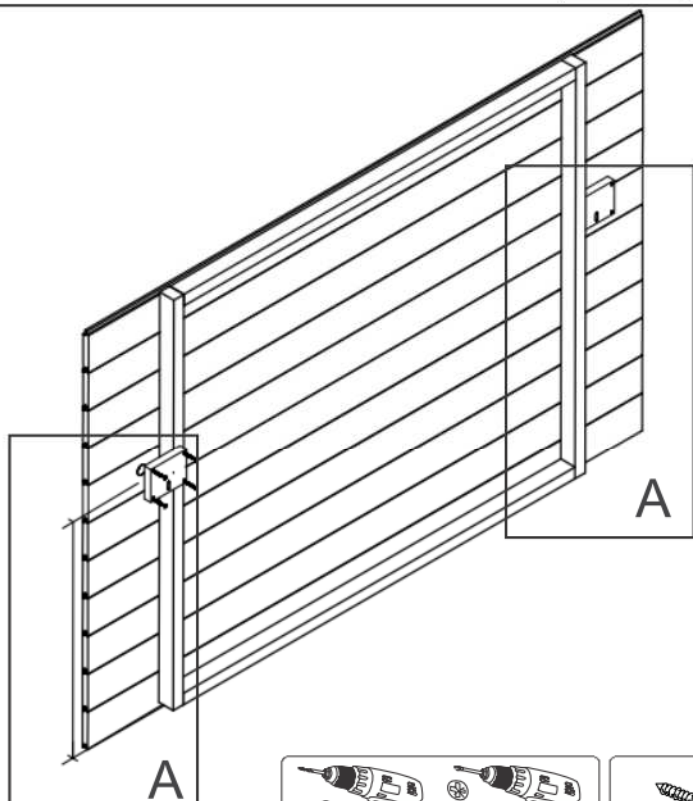

A

A

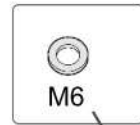

M6

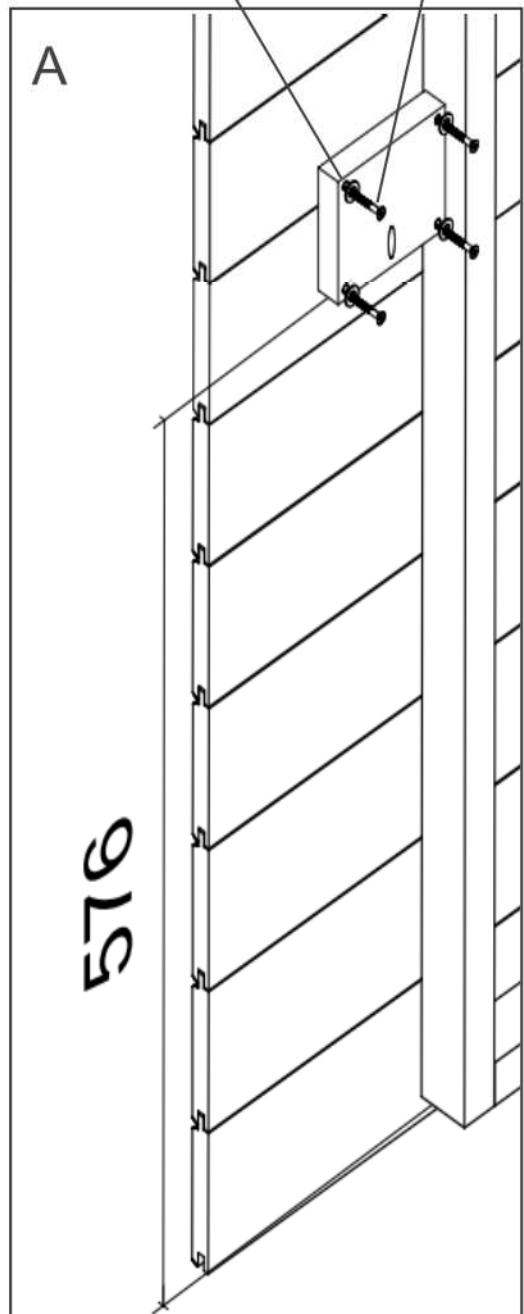

A

576

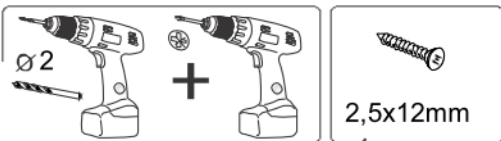

Ø2

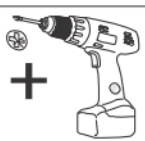

+



2,5x12mm

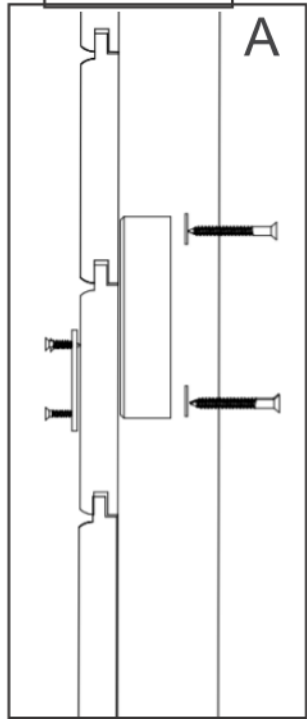

A

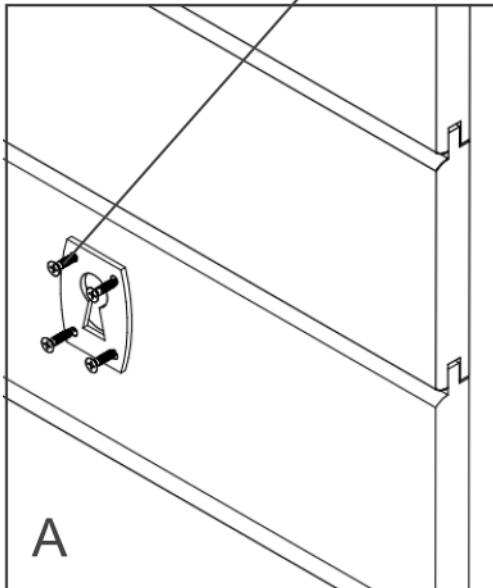

A

8

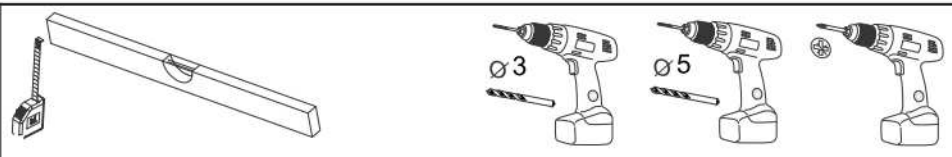

POS

- 10  1554x1018 1X
- 11  43x90x1000 2X
- 12  43x90x1192 2X
- 13  28x65x1000 2X
- 16B  20,6x27,6x300 4X
- 19  13,5x75x1554 1X

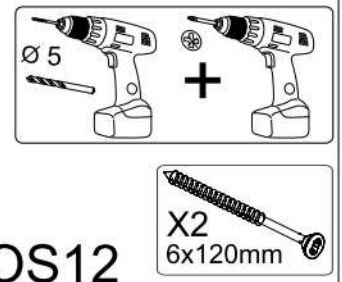
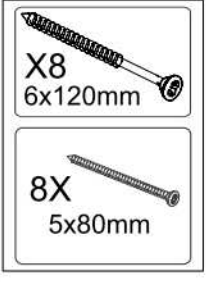

POS19

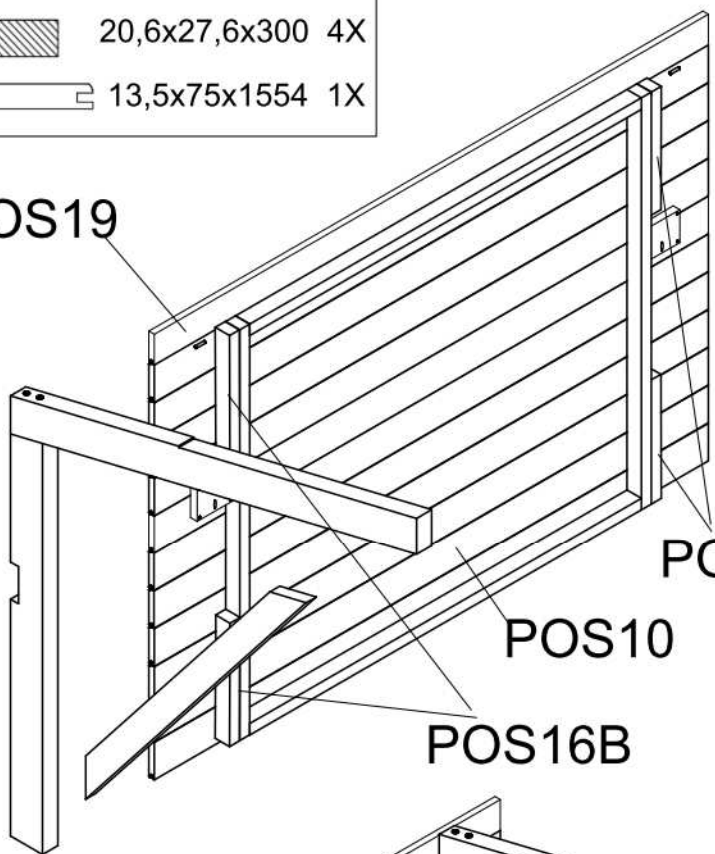

POS12

POS13

POS11

POS16B

POS10

POS16B

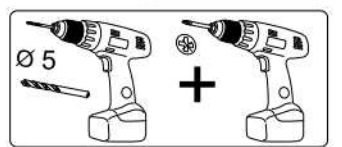
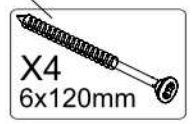
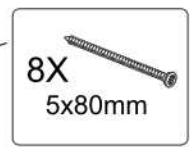
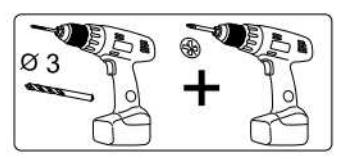

9

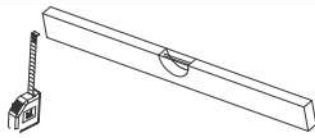

POS

25



2X



X1 R

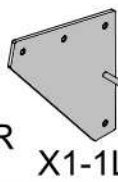

X1-1L

X8



4x60mm

X12



3,5x35mm

2X

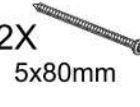

5x80mm

2X



M6



+

X4



3,5x35mm

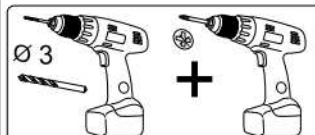

+

X4

3,5x35mm

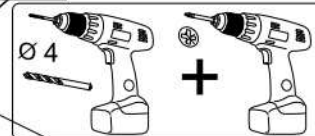

+

M6



5x80mm

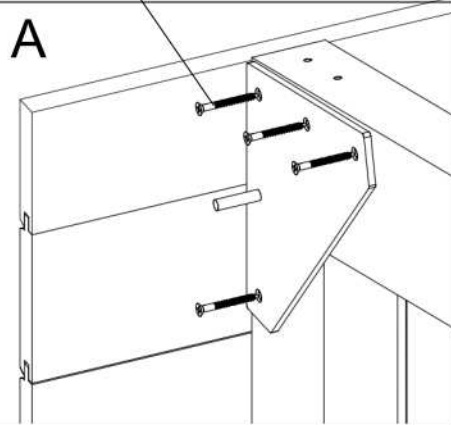

A

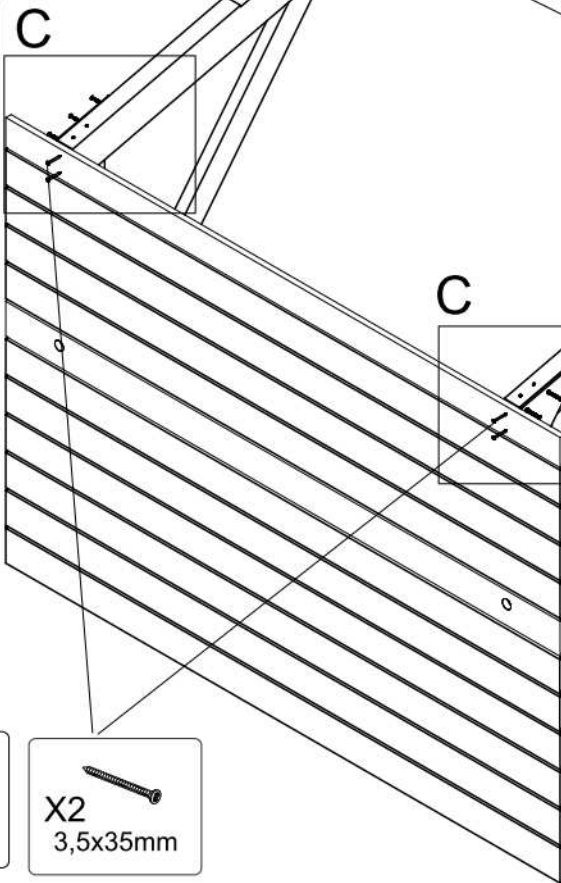

C

C

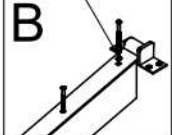

B

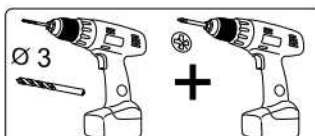

+

X2

3,5x35mm

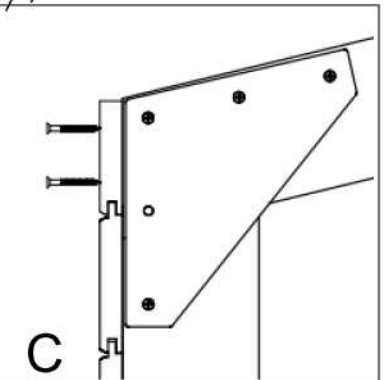

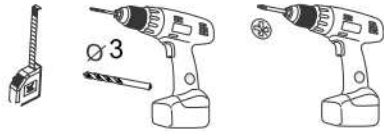

C

10



POS

- 14A  28x40x1310mm 2X
- 14B  28x40x1535mm 4X
- 14C  20,6x27,6x1535mm 1X

10X  
4x60mm

6X  
5x80mm

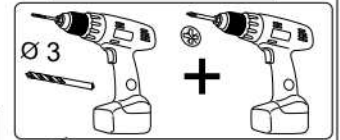
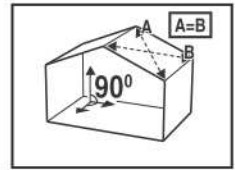

4x60mm

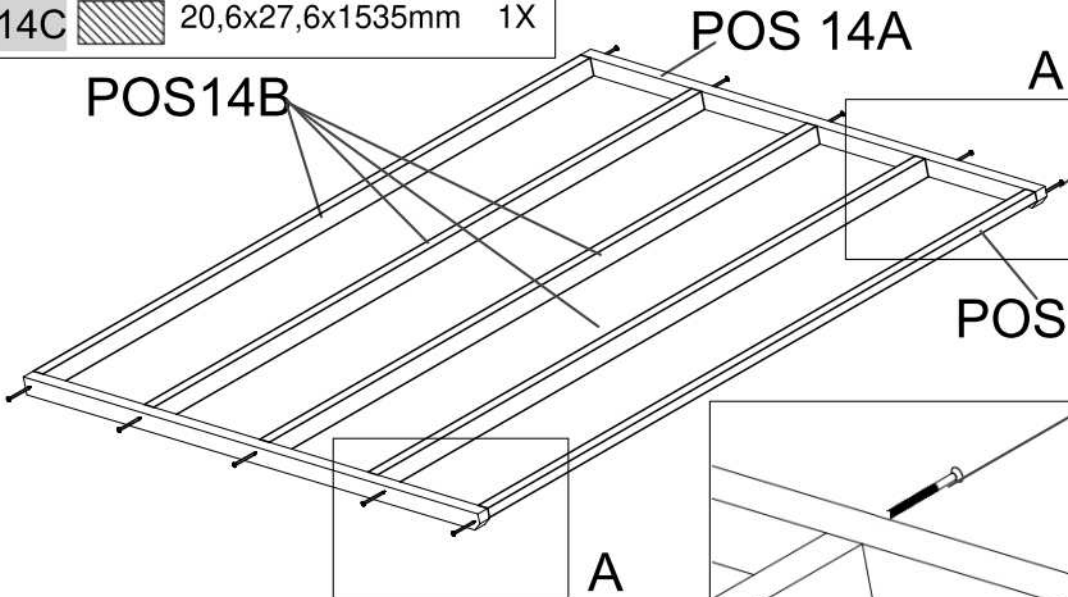

POS14C

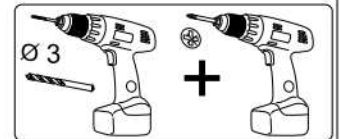
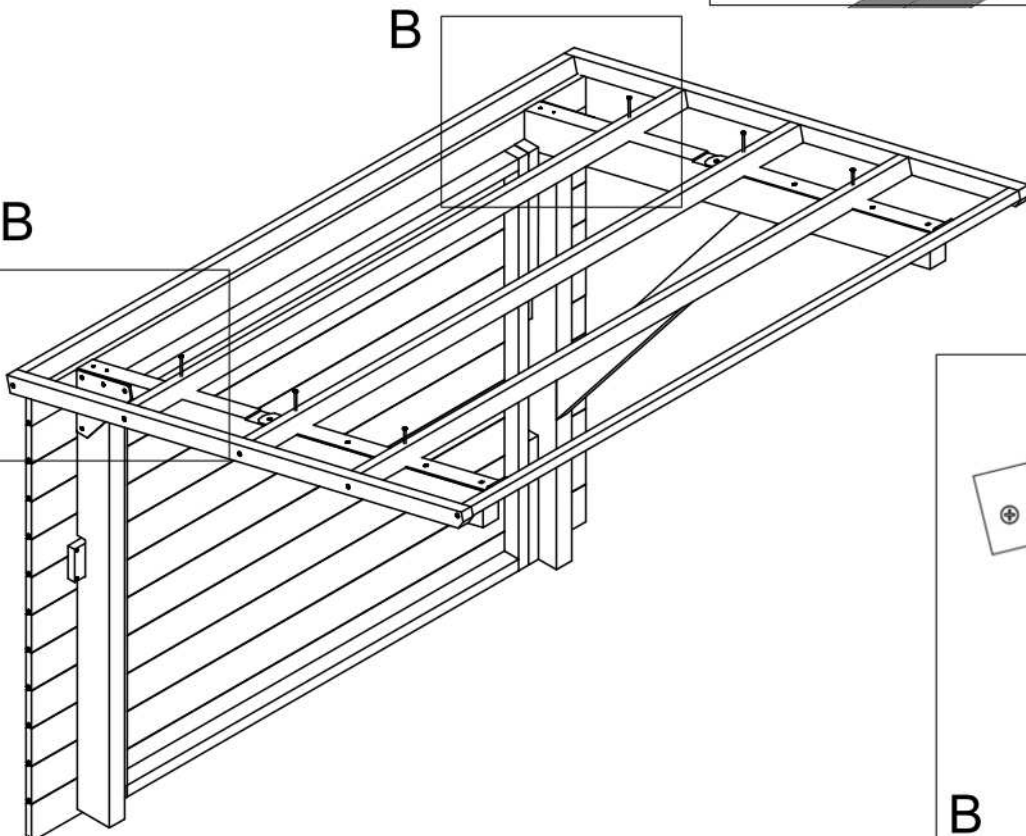
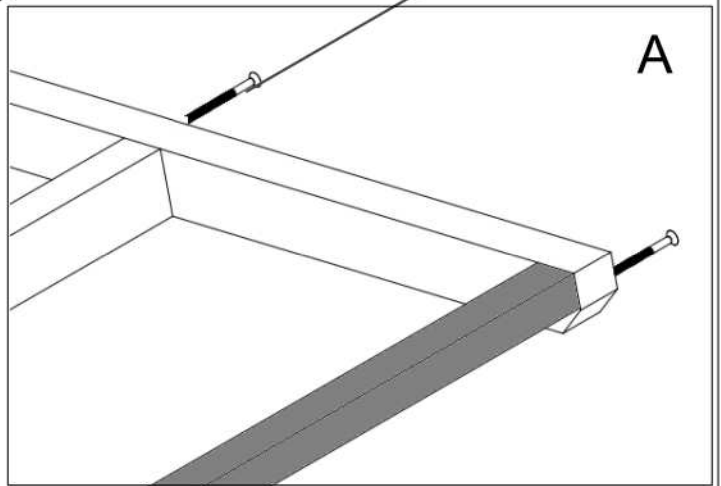

5x80mm

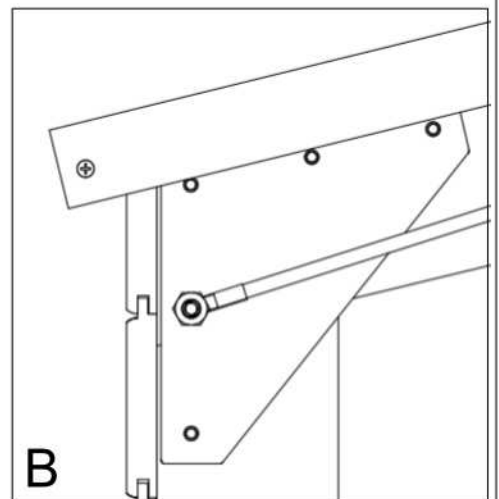

11



POS

26

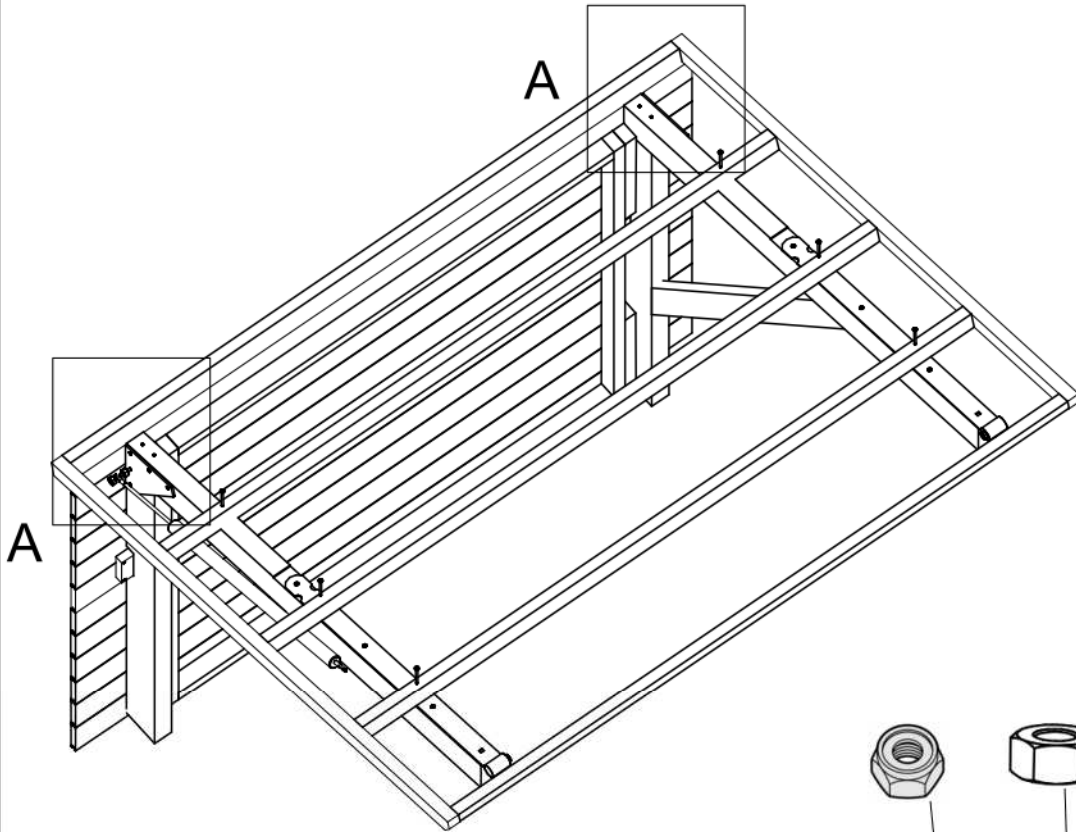

POS 26

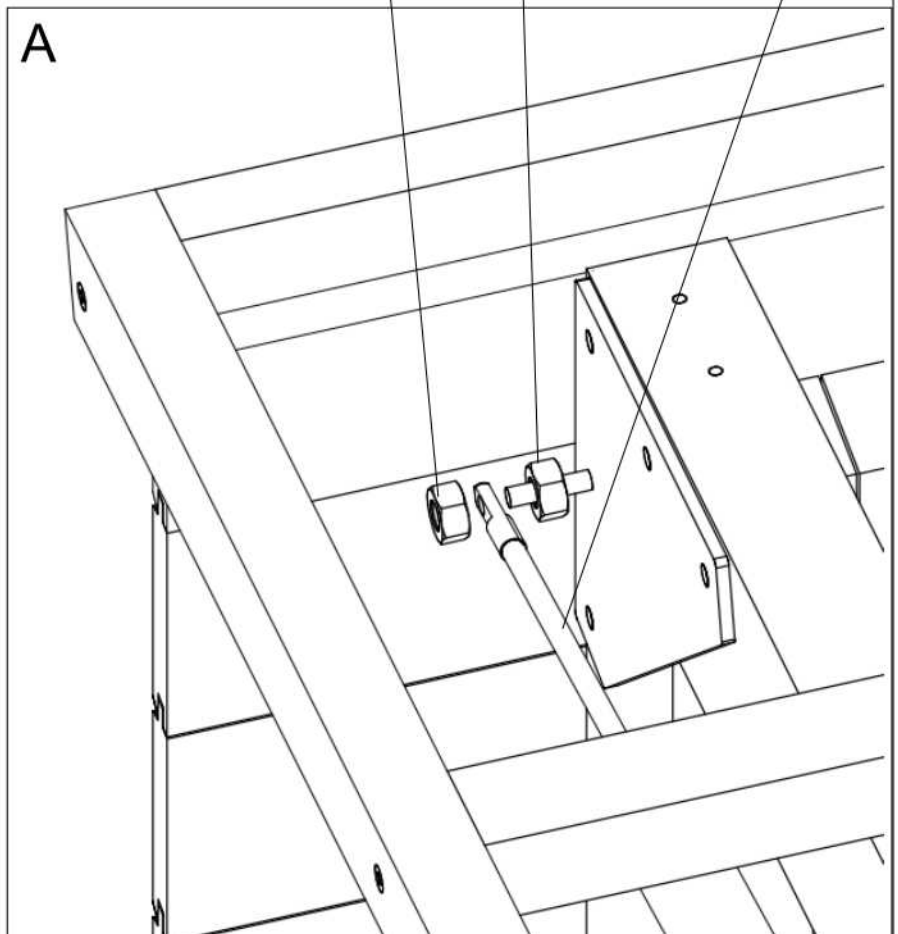



12

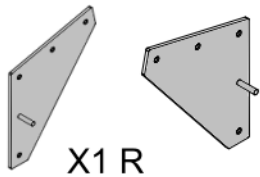
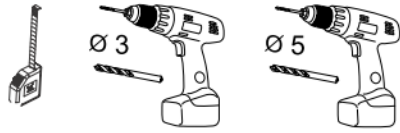

X1 R

X1 L



X8  
3,5x35mm



X4  
6x120mm



X4  
5x80mm

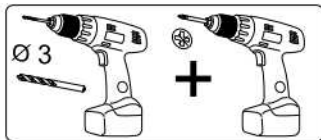
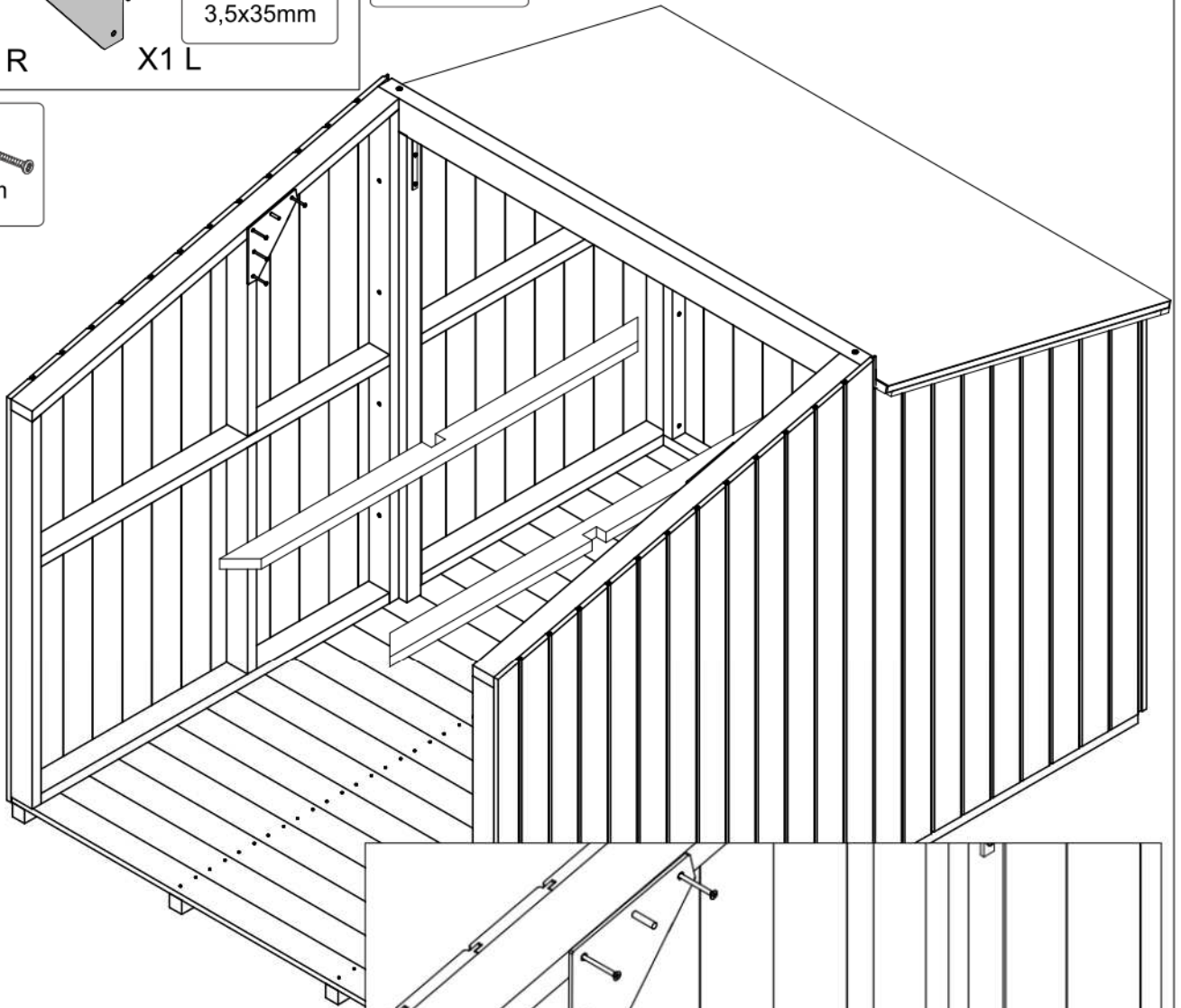

Ø 3

+



3,5x35mm

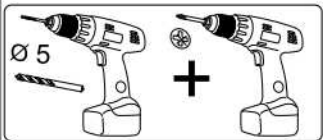

Ø 5

+



6x120mm

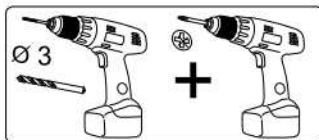

Ø 3

+

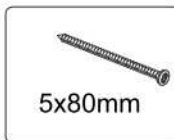

5x80mm

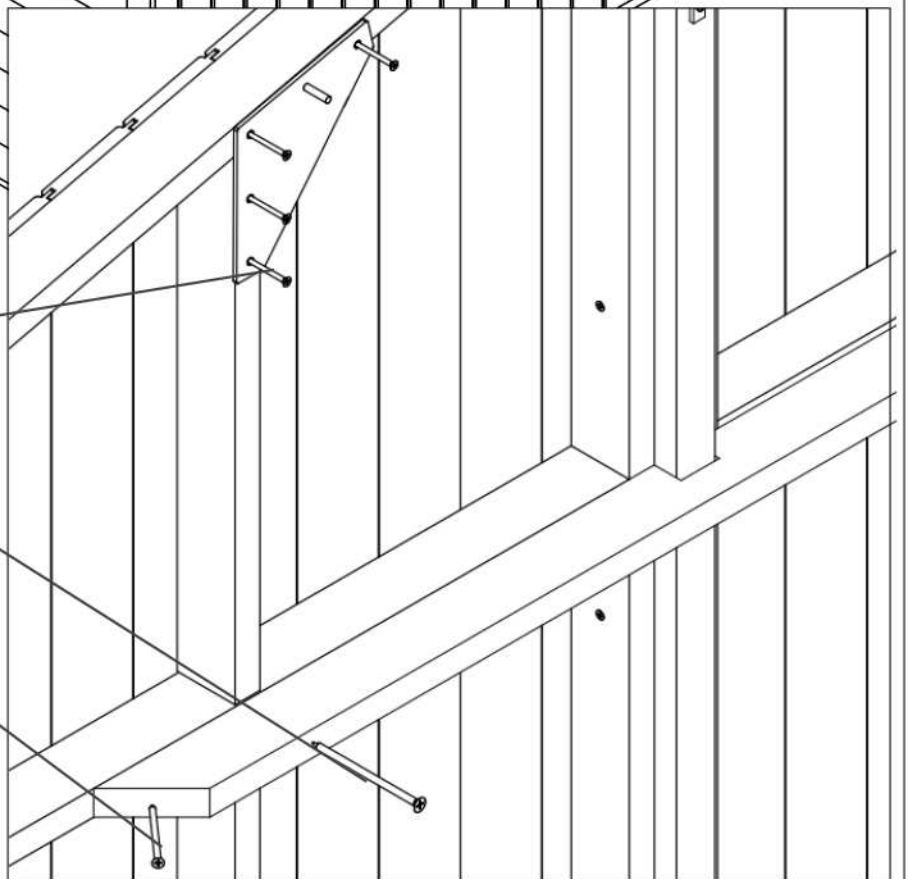

13

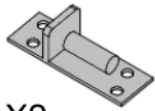
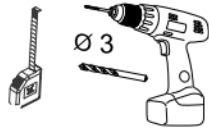

X2



X8  
5x80mm

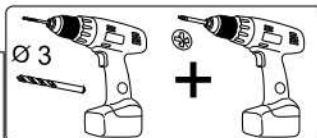
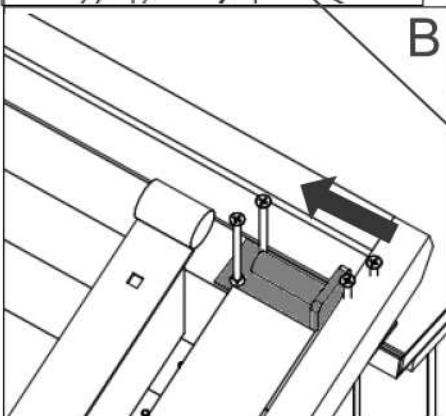
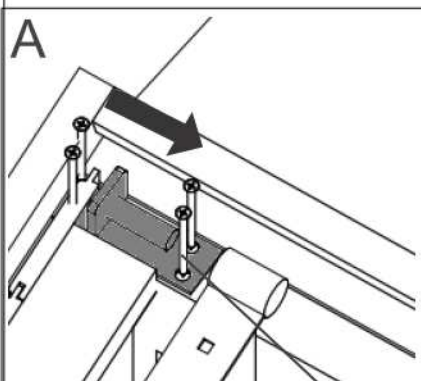
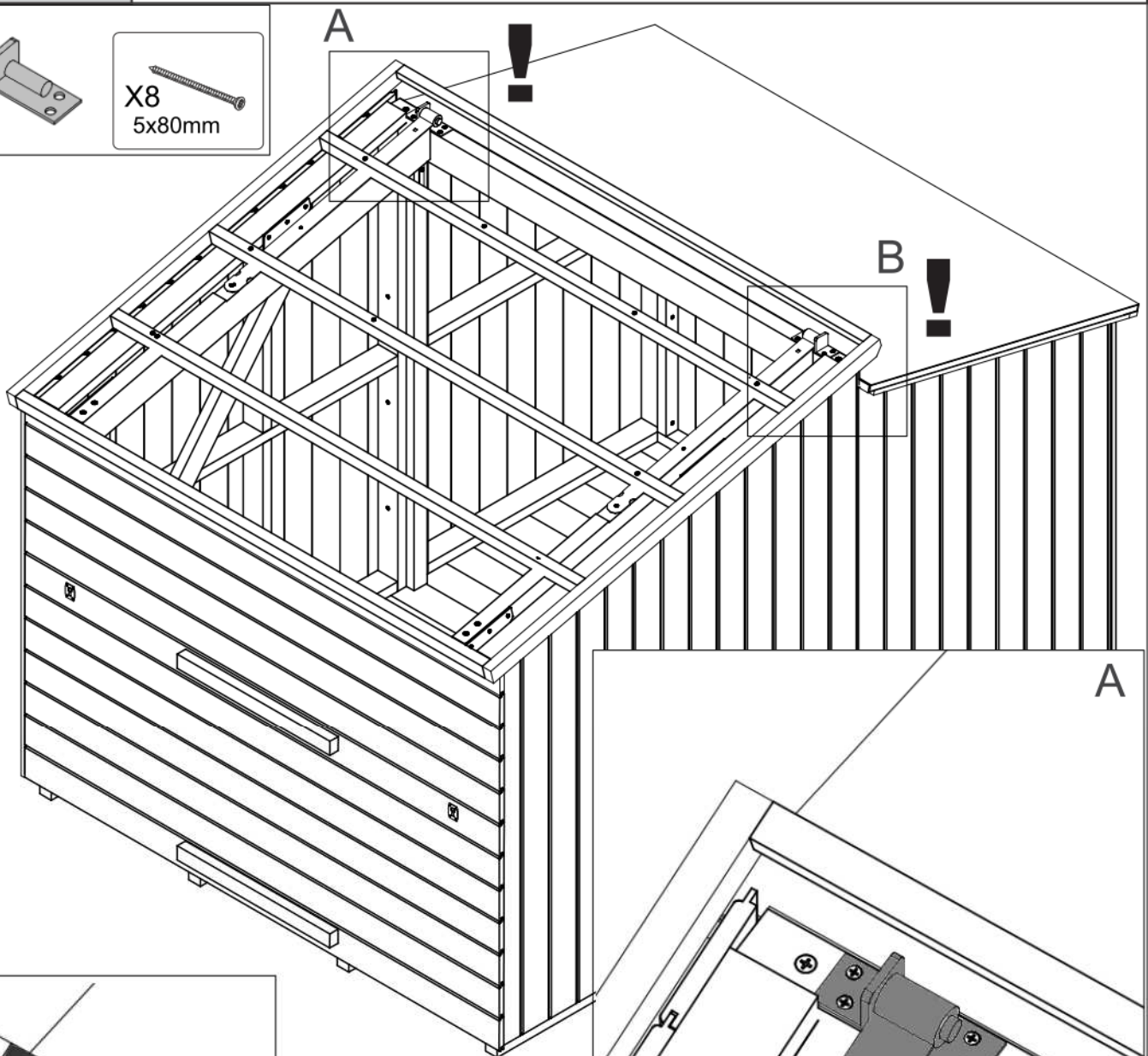

X4  
5x80mm

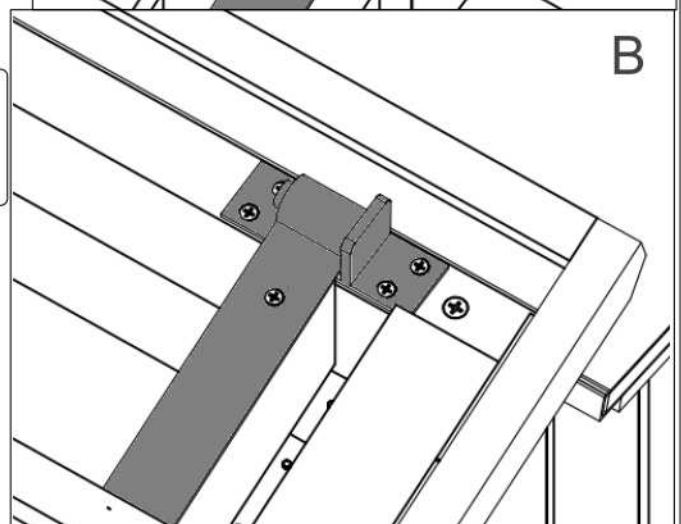

14

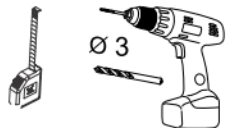

POS

16A



27,6x40x500 2X



X2



X2



X16

3,5x35mm

POS 16A

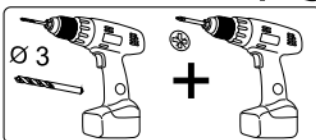

X4  
3,5x35mm

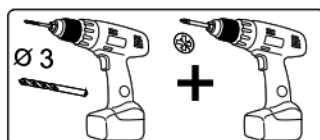
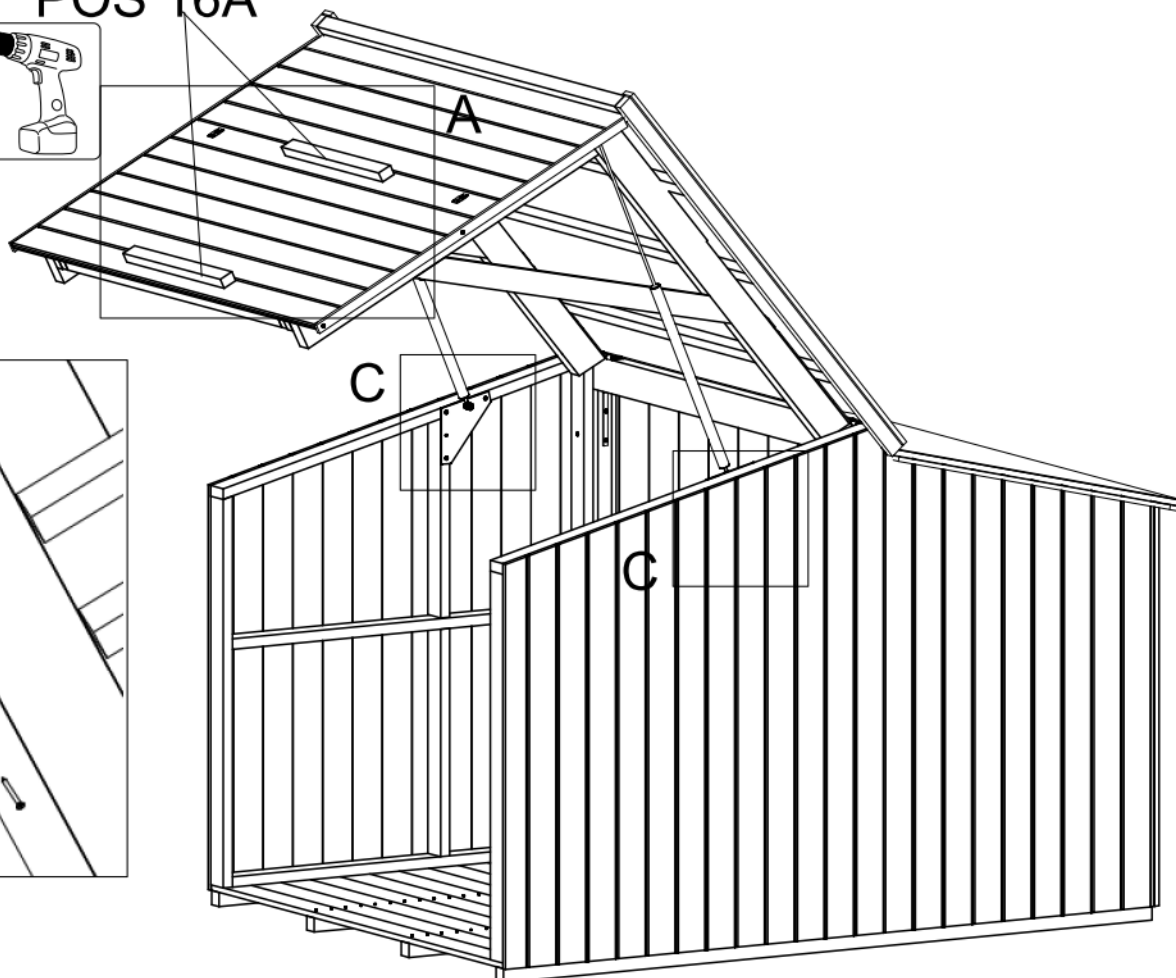
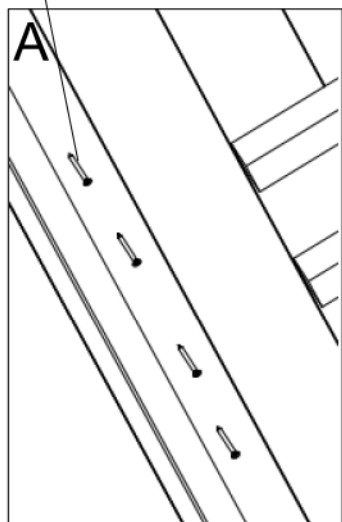



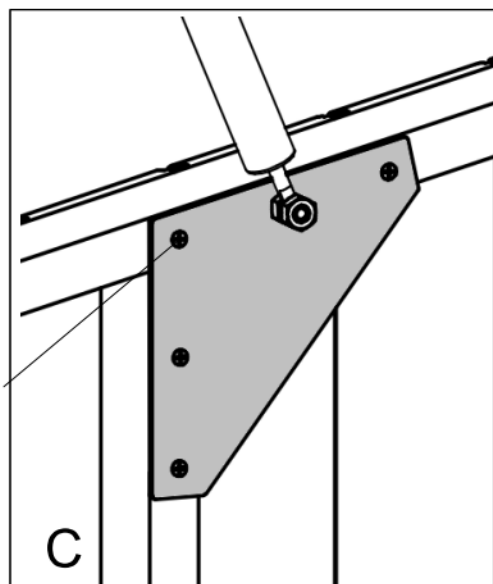

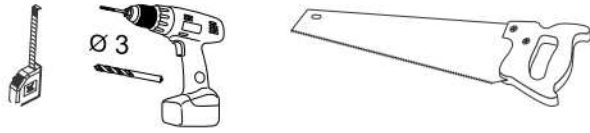

X4  
3,5x35mm



15



POS

- 15  12x26x1060 2X
- 27  12x42x1356 2X  12x42x1310 2X
- 28  12x42x1510 1X  12x42x1506 1X
- 24.  750x1580 2X

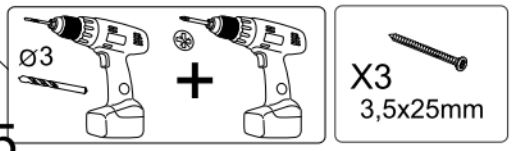
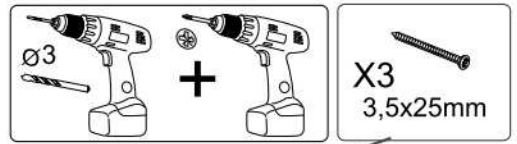
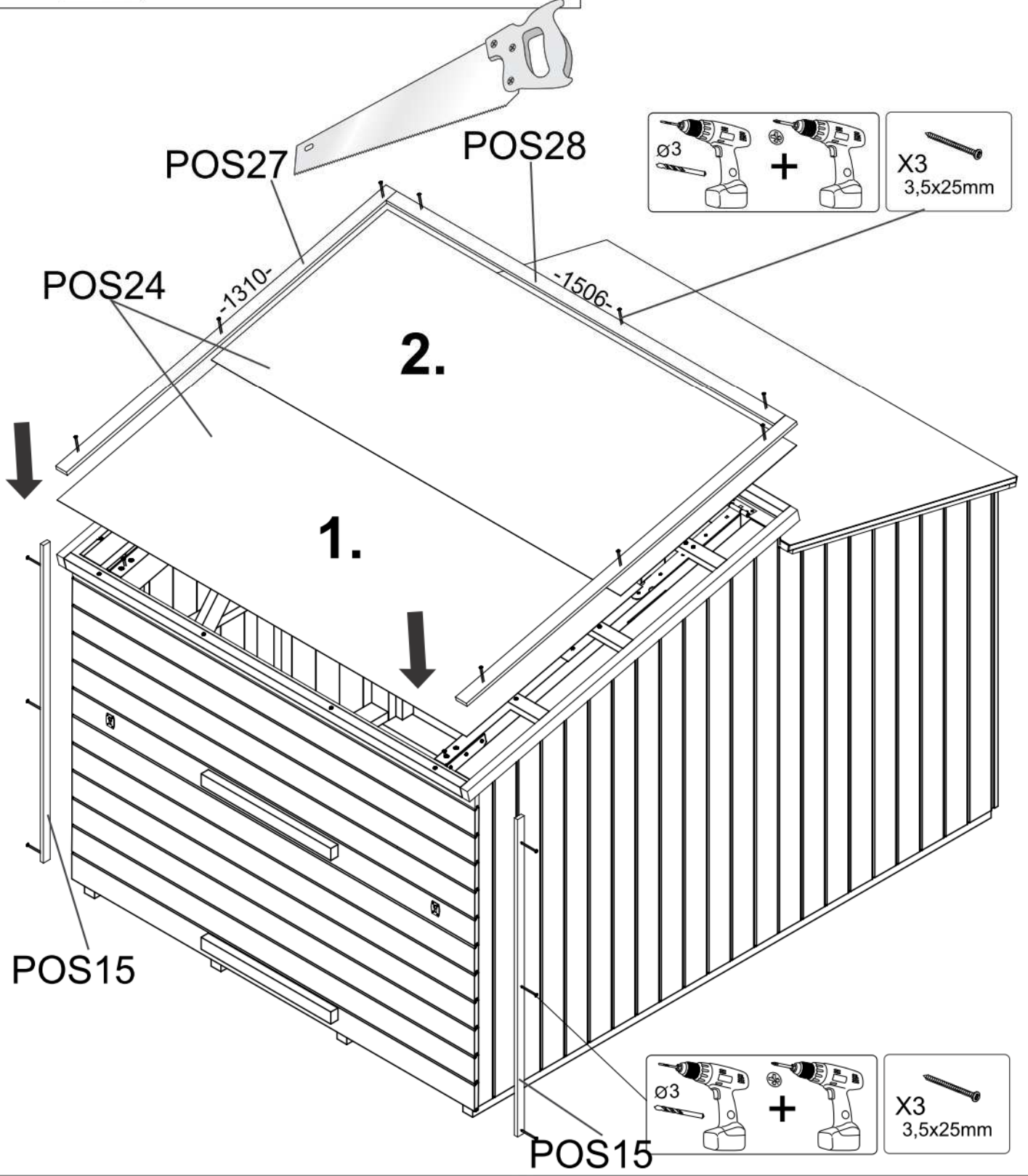

16

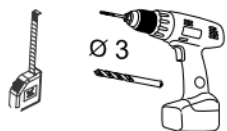

X16  
3,5x25mm

X16  
5,5x16

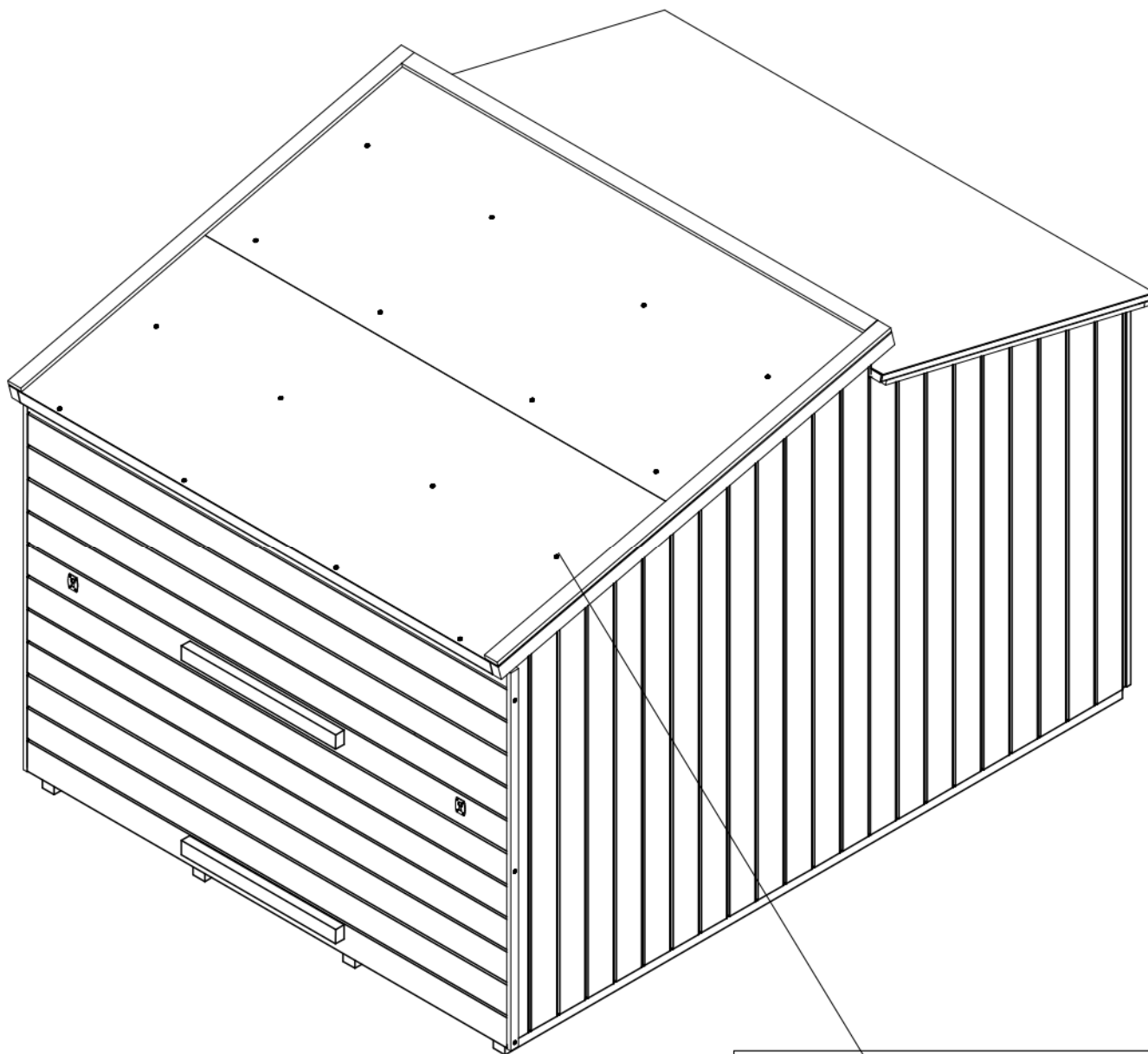

5,5x16

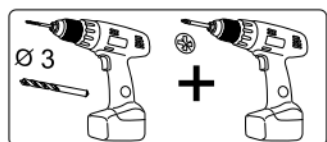

X3  
3,5x25mm

