

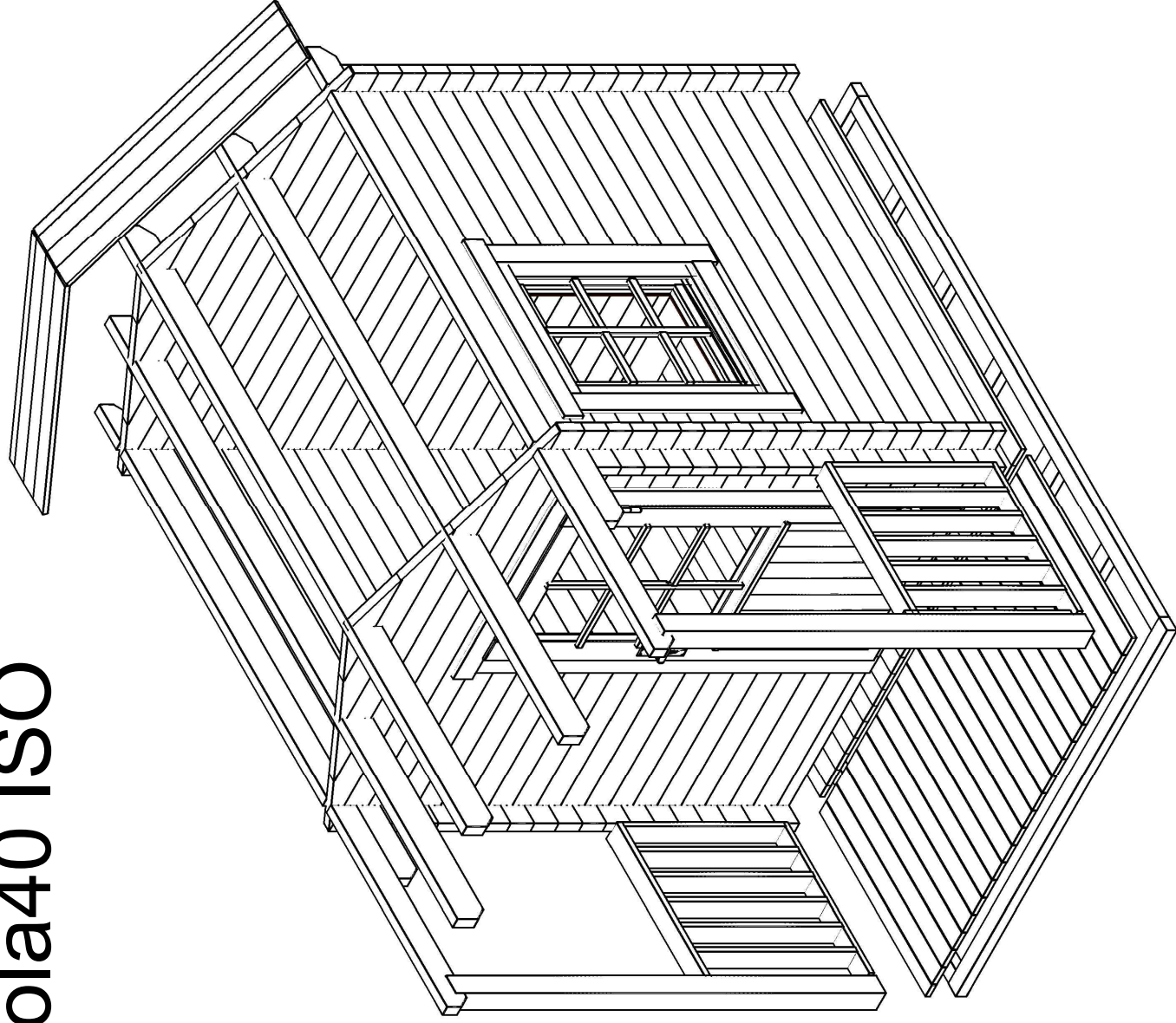

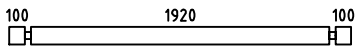







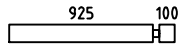
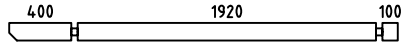
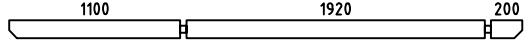
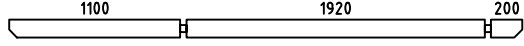

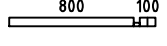

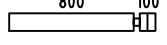
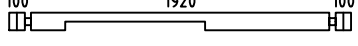
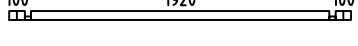
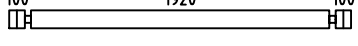
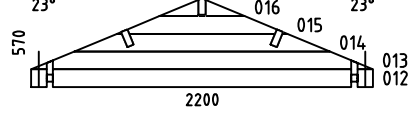
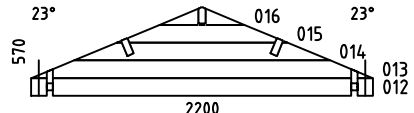
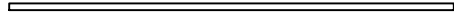



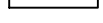

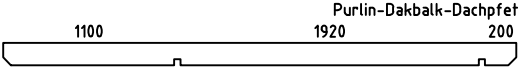
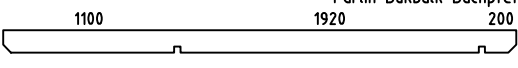
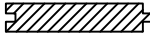
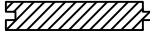

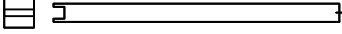











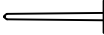



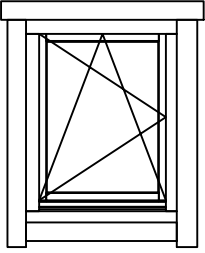
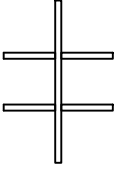
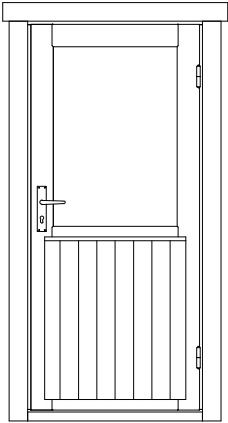
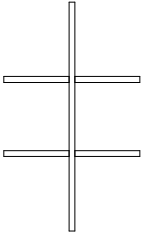

Sauna Nikola40 ISO



Pos	Specification-Spezifikation-Specificatie Nikola40 ISO	St.	Profile (mm)	Length (mm)
001		25	40x114	2200
002		9	40x114	360
003		9	40x114	1065
004		2	40x114	2500
005		1	40x114	3300
006		1	40x114	3300
007		1	40x57	360
008		1	40x57	940
009		16	40x114	360
010		16	40x114	940
011		1	40x114	2200
017		1	40x57	2200
018		17	40x114	2200
WA-1		1		
WB-1		1		
FB3	FOUNDATION BEAM-FUND.BALKEN-FUND.BALK 	2	70x44	2860
FB1	FOUNDATION BEAM-FUND.BALKEN-FUND.BALK 	2	70x44	2000
FB2	FOUNDATION BEAM-FUND.BALKEN-FUND.BALK 	6	70x44	1860
UBS1	UPPER BENCH SUPPORT-TRAGELEISTE FÜR SAUNABANKE OBEN-STEUNEN BAR VOOR BOVENSTE SAUNABANKEN 	1	44x70	1832
UBS2	UPPER BENCH SUPPORT-TRAGELEISTE FÜR SAUNABANKE OBEN-STEUNEN BAR VOOR BOVENSTE SAUNABANKEN 	2	44x70	570
LBS1	LOWER BENCH SUPPORT-TRAGELEISTE FÜR SAUNABANKE UNTEN-STEUNEN BAR VOOR NEER SAUNABANKEN 	2	44x70	470

Pos	Specification-Spezifikation-Specificatie Nikola4.0 ISO	St.	Profile (mm)	Length (mm)
PR1	 Purlin-Dakbalk-Dachpfette 1100 1920 200	2	44x144	3300
PR2	 Purlin-Dakbalk-Dachpfette 1100 1920 200	1	44x144	3300
VB-1	Floor board-Fussbodenbrett-Vloerplank 	22+1	88x18	1910
DP-1	Roof board-Dachbrett-Dakplank 	76+1	88x18	1350
TB-1	Terrace board-Terrassendiele-Vlonderplank 	21+1	88x18	1000
	-POST 85x85 	2		2070
	Base Board-Fussbleiste-Plinten 18x40x3000 	4	18x40	12rmt.
L-1	Eave Board-Traubret-Dakranden board 95 	2	18x95	3300
L-2	Eave Slat-Traufenleiste-Afdekljst 	2	40x18	3300
L-3	Facia Board-Giebelblende-Gevelplank 	4	18x120	1390
L-4	Facia Slat-Giebelleiste-Gevelljst 	4	40x18	1390
TR21	Threaded rod Set-Gewindestange Satz-Draadstang Set2 	4	M10	2260
	Adjustable foot-Stellfuß+Schrauben 5x40 4stück für Post 	2		
	Backrest-Rückenlehne-Rug Leuning 1960 	1	235x1720	
D1	Diamond 	2		
	Door Set-Tür Satz-Deur Set 	1		
	Heater Guard-Ofenschutz gitter-Openhaard Guard 	1	562x602	
	Lower Bench-Saunabank unten-Sauna onderstel zitbank 1960 	1	500x1918	
	Nail-Nagel-Spijker 1.6x30 	15	1.6x30	
	Sauna Ventilation Set-Sauna Lüftungsluke 	1		
	Screw-Schraube-Schroef 4x50 	20		
	Screw-Schraube-Schroef 5x70 	30		
	Upper Bench-Saunabank oben-Hoge Saunabank 1960 	1	600x1918	
Kood	Sauna Nikola4.0 ISO	Materjal	File SaunaNikola4.0 ISO.dwg	Leht 2/3

Pos	Specification-Spezifikation-Specificatie Nikola40 ISO	St.	Profile (mm)	Length (mm)		
	Window Handle Set-Fenstergriff Satz-Raamgreep Set 	1	3x25			
	WINDOW 765x980 W6DK 76.5x98 ISO L TEMPERED  Window Glazing Bar Fenstersprossen Raamroeden 	1				
	DOOR 890x1900 SD6 89x190 ISO R TEMPERED  Door Glazing Bar Türsprossen Deurroeden 	1				
LG1	Lattice-Sichtschutzgitter 	2	845x800			
P1	Board-Brett-Plank 	4	18x95	845		
P2	Board-Brett-Plank 	4	18x95	764		
P3	Board-Brett-Plank 	20	16x70	776		
	Handrail-Handlauf 	2	18x95	845		
	Screw-Schraube-Schroef 4x35 	8				
	Screw-Schraube-Schroef 4x60 	32				
Kood	Sauna Nikola40 ISO	Materjal	File	SaunaNikola40 ISO.dwg	Leht	3/3

H = 1,600 m
 TOTAL: 3,69 m²

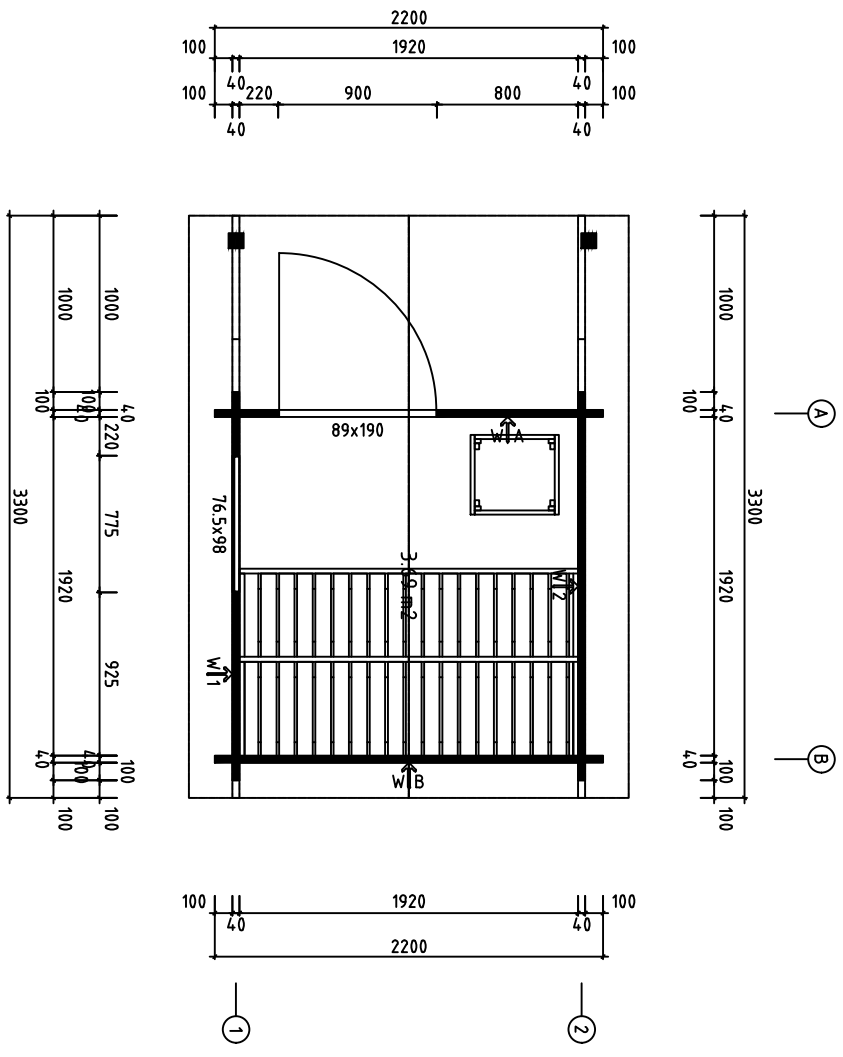

Model	Sauna Nikolai4.0 ISO	Page	PLAN
Drawn by	Material 4.0x114	Scale	1:30
Date	19.01.2022	File	Sauna Nikolai4.0 ISO

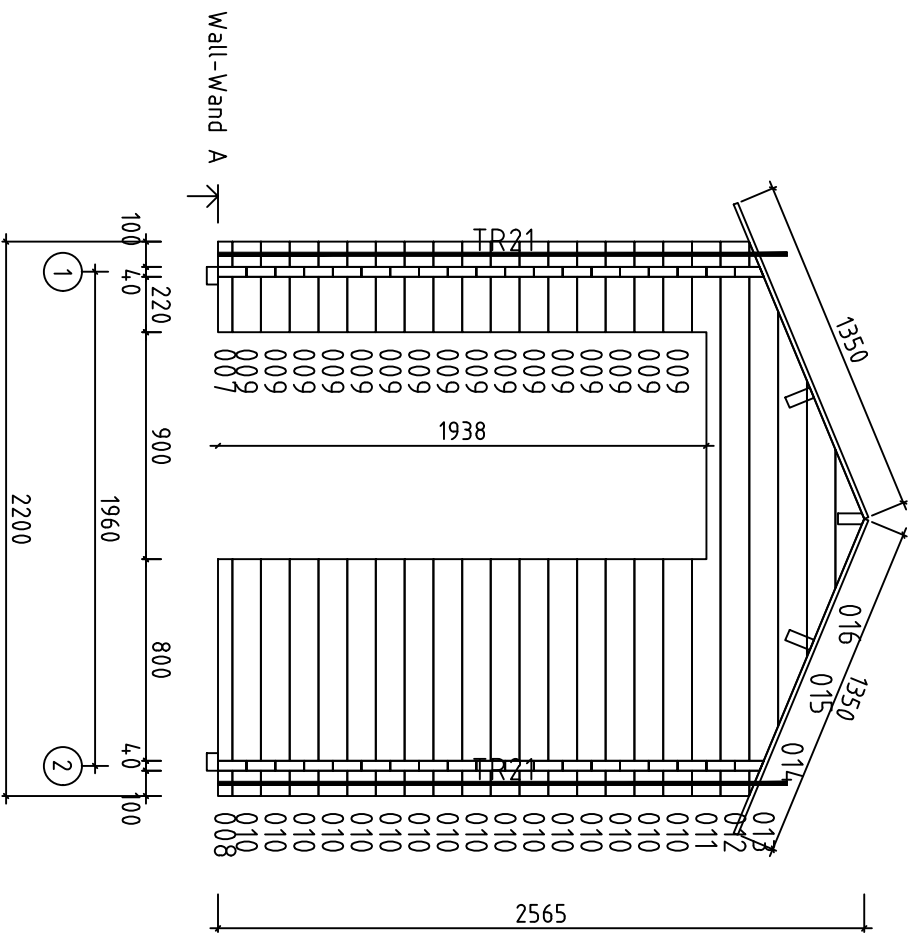

Model	Sauna Nikola4.0 ISO		Page	3
Drawn by	Material	4.X11.4	Scale	1:30
Date	19.01.2022			
File	Sauna Nikola4.0 ISO			

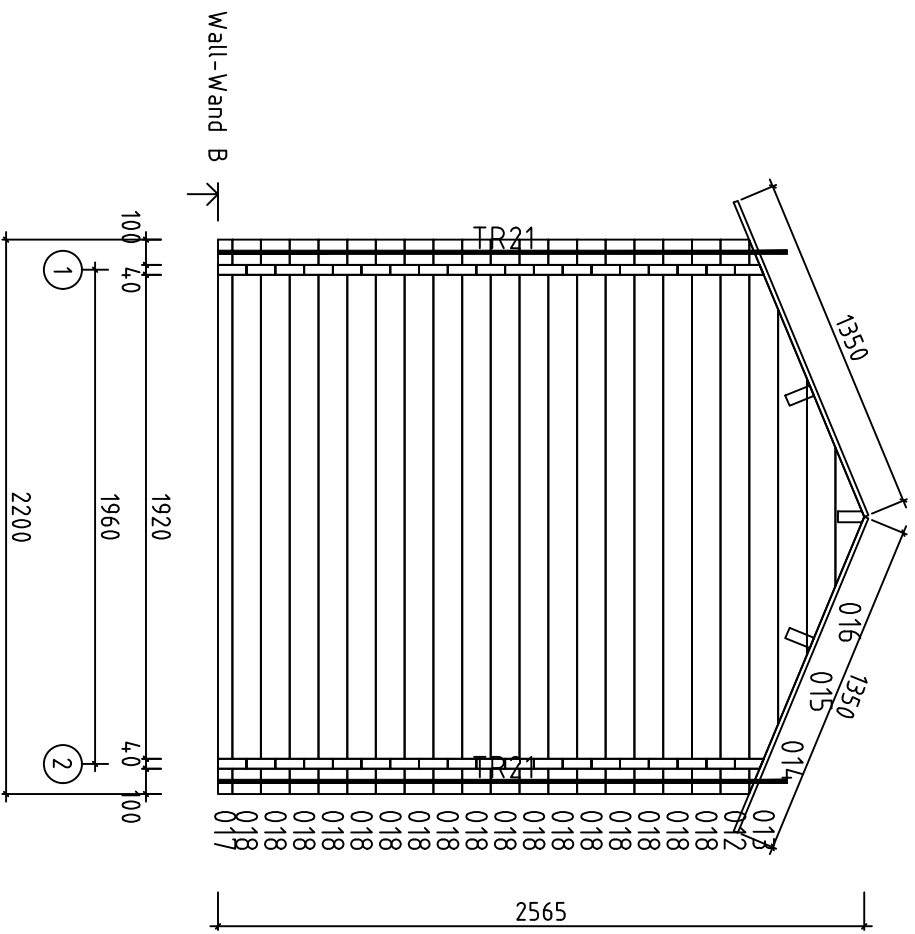

Model	Sauna Nikola4.0 ISO		Page	4
Drawn by	Material	4.X11.4	Scale	1:30
Date	19.01.2022		File	Sauna Nikola4.0 ISO

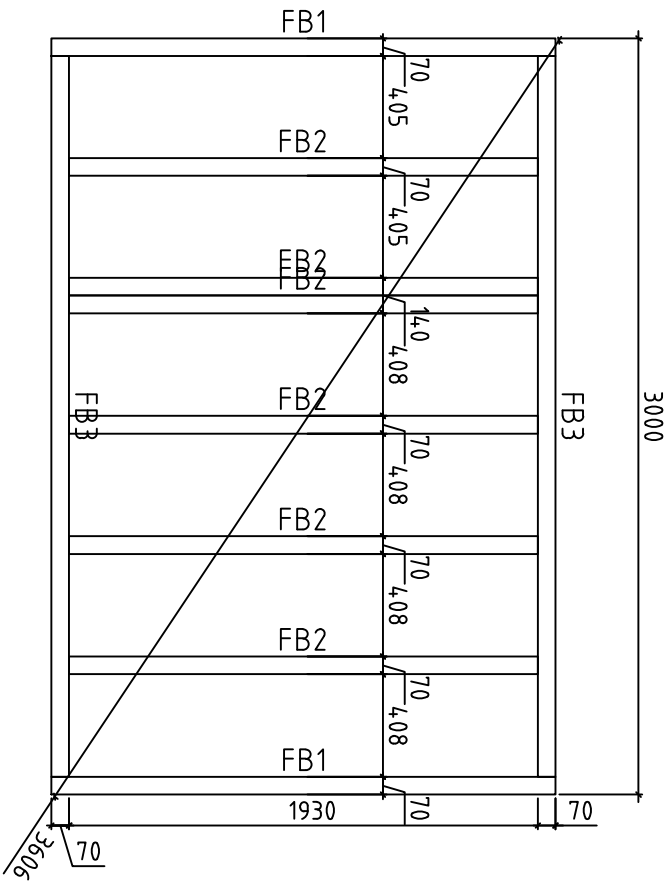

Model	Sauna Nikola4.0 ISO		Page	FOUNDATION
Drawn by	Material	4.0X114	Scale	1:30
Date	19.01.2022		File	Sauna Nikola4.0 ISO

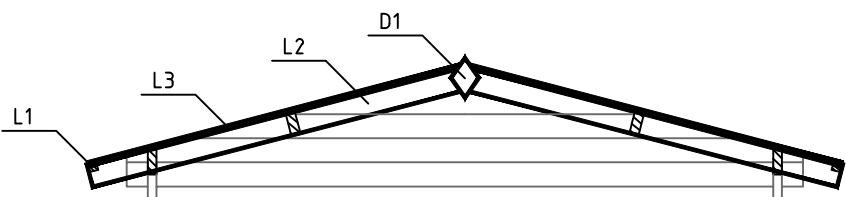
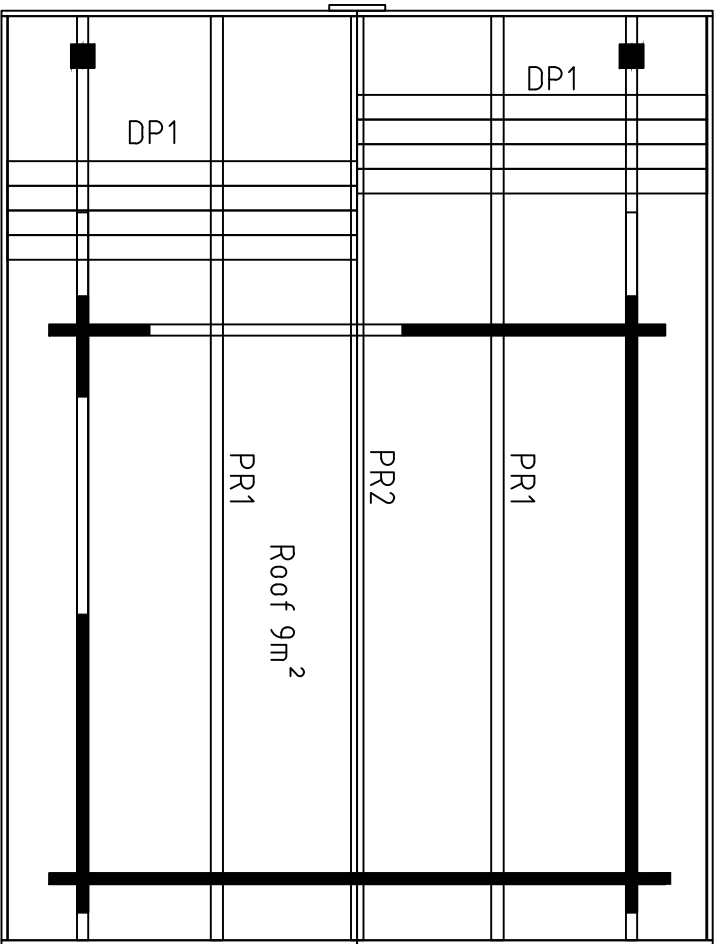

Model	Sauna Nikola40 ISO		Page	ROOF
Drawn by	Material	40x114	Scale	1:30
Date	19.01.2022		File	Sauna Nikola40 ISO

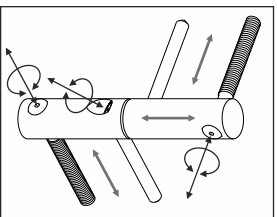
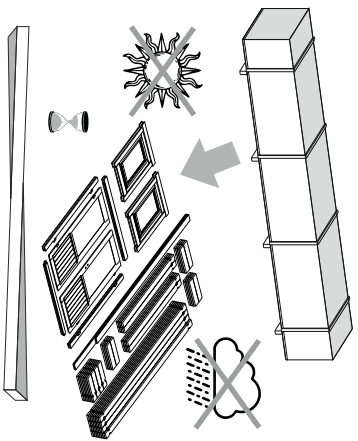
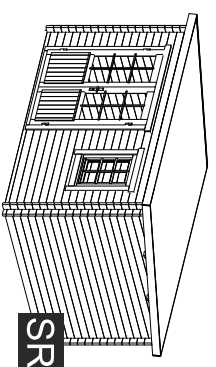
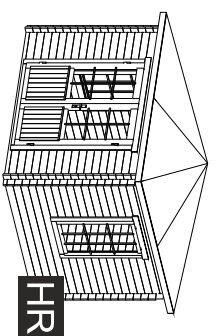
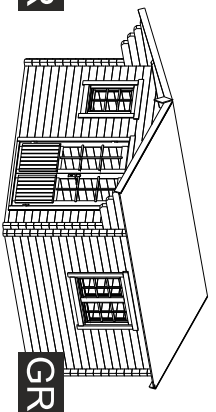
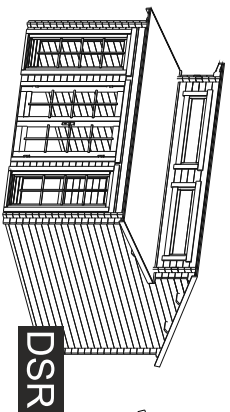
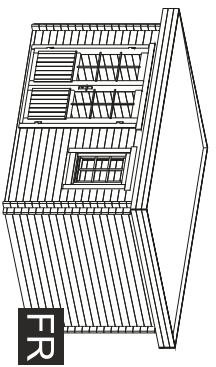

ADJUSTABLE HINGES

TYPE-A
5x90

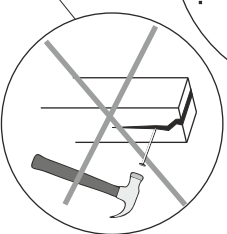
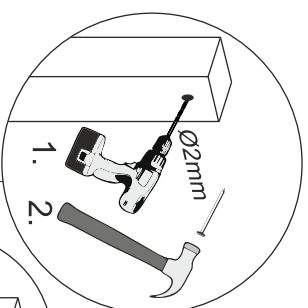

OPTIONS

OPTIONS

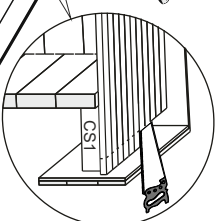

Ø4mm

Ø4mm

Ø21mm

TYPE-A
5x70

TYPE-B
4x60

NBI

A=B

1.

2.

3.

4.

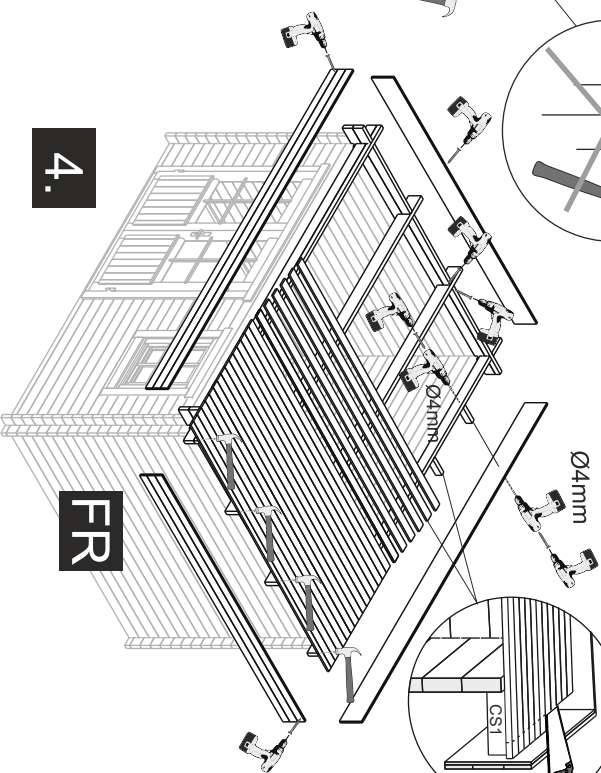
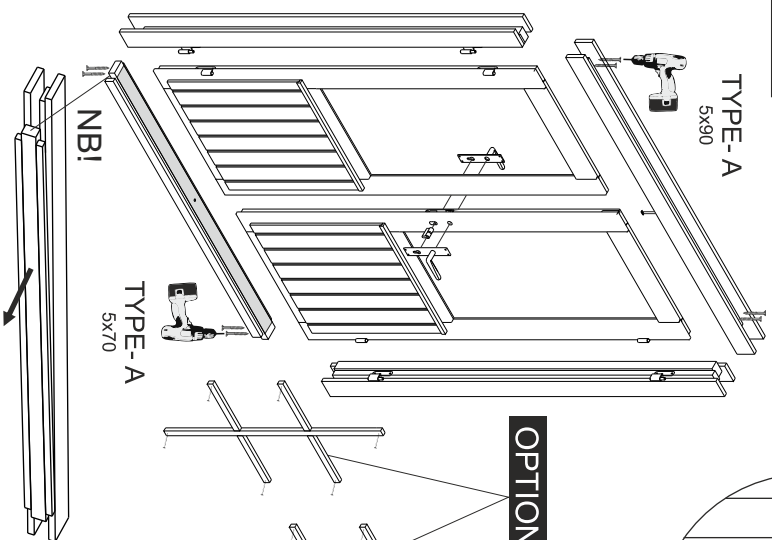
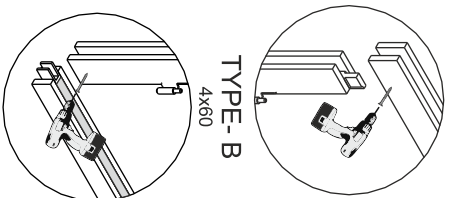
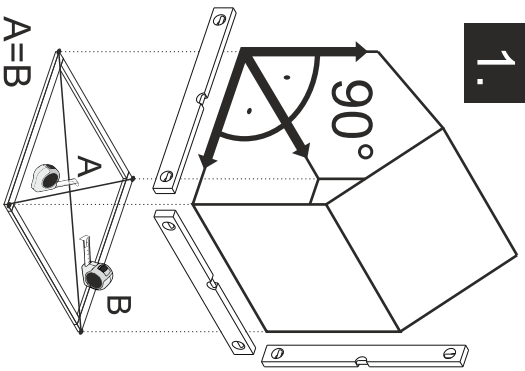

The guide is illustrative. This guide is not project specification.
 Der Leitraden ist illustrativ. Dieser Leitraden ist keine Projektspezifikation.
 De gids is illustratief. Deze gids is geen projectspecificatie.

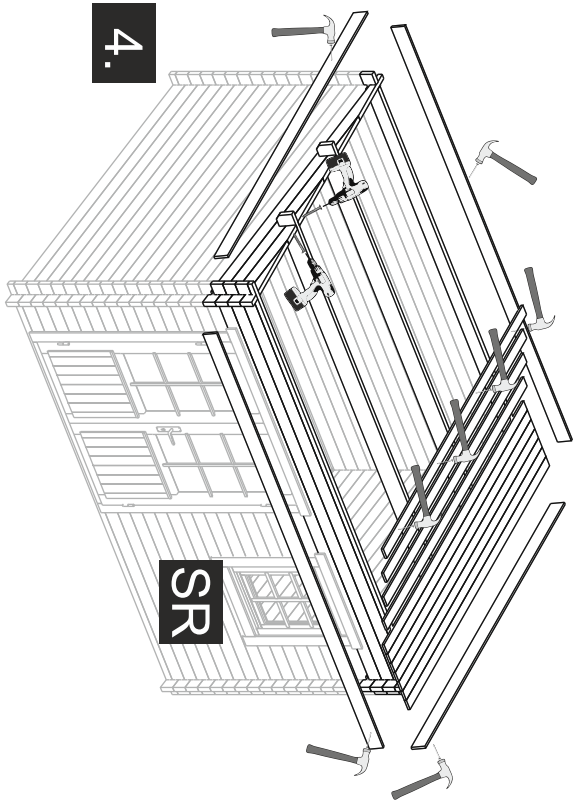
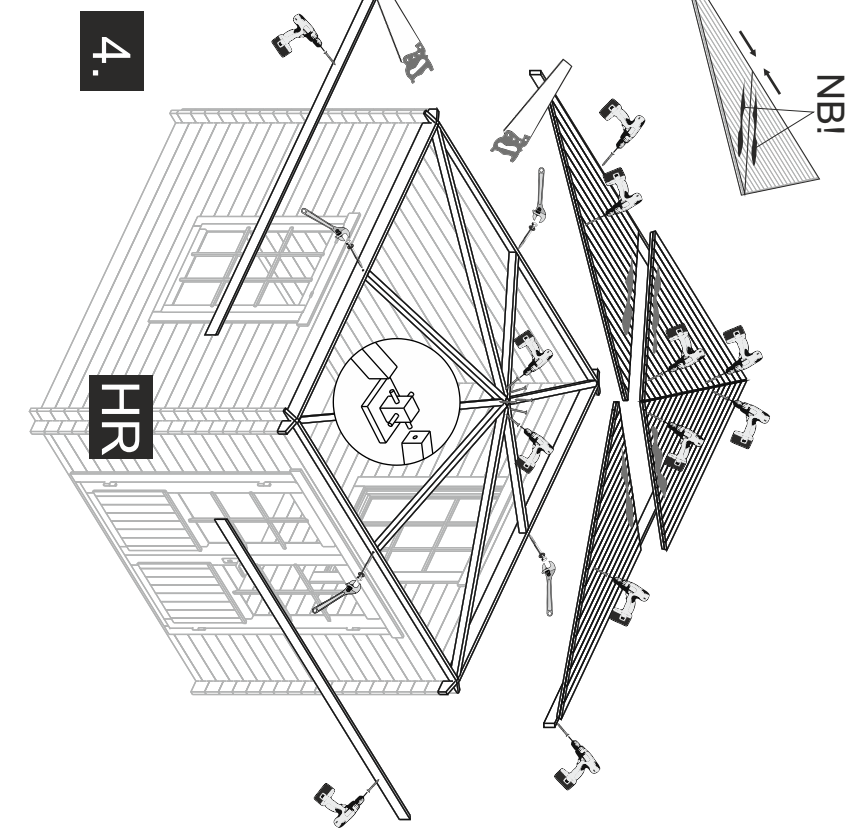
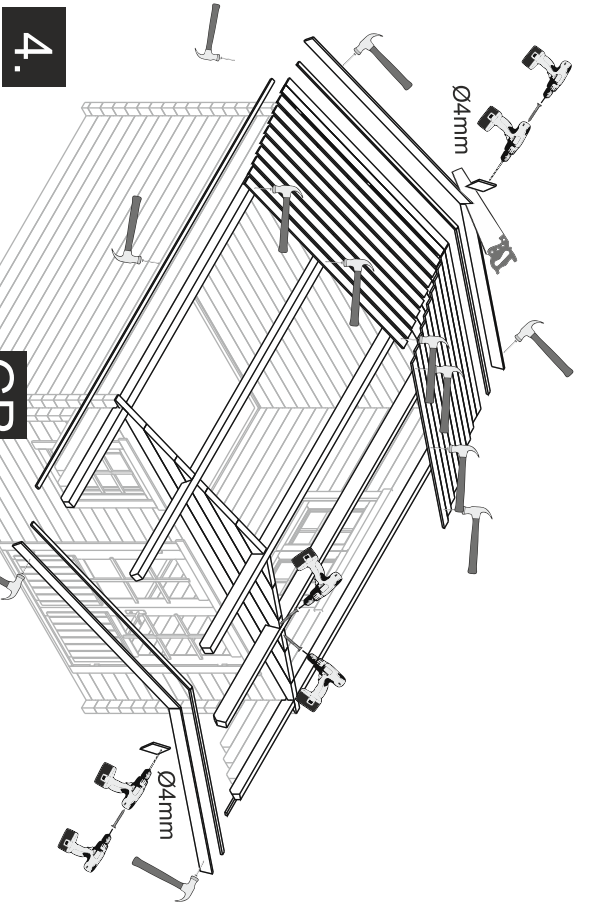
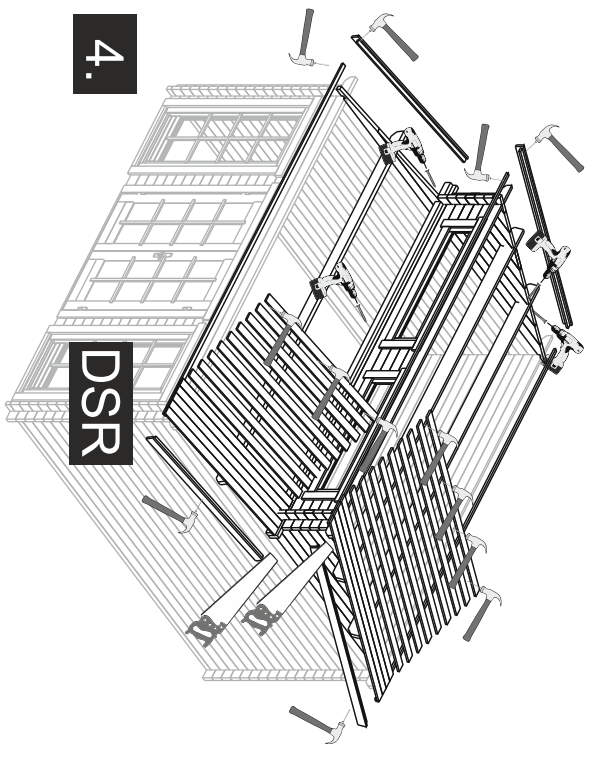

OPTIONS

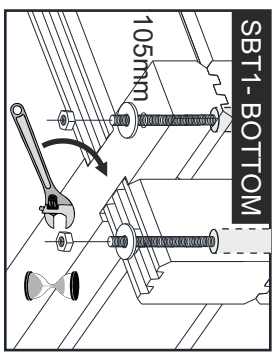
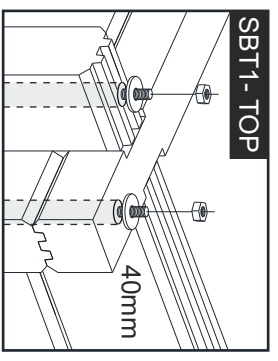
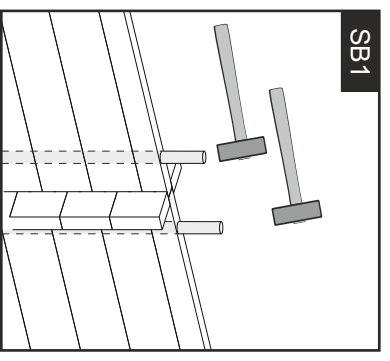

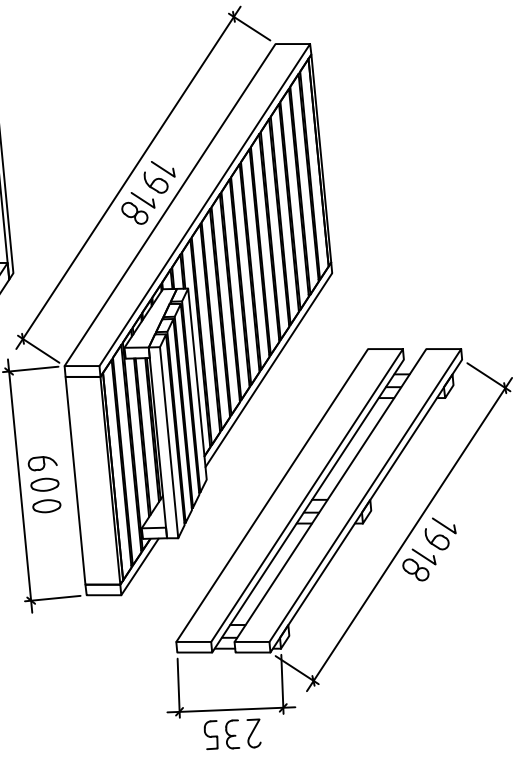
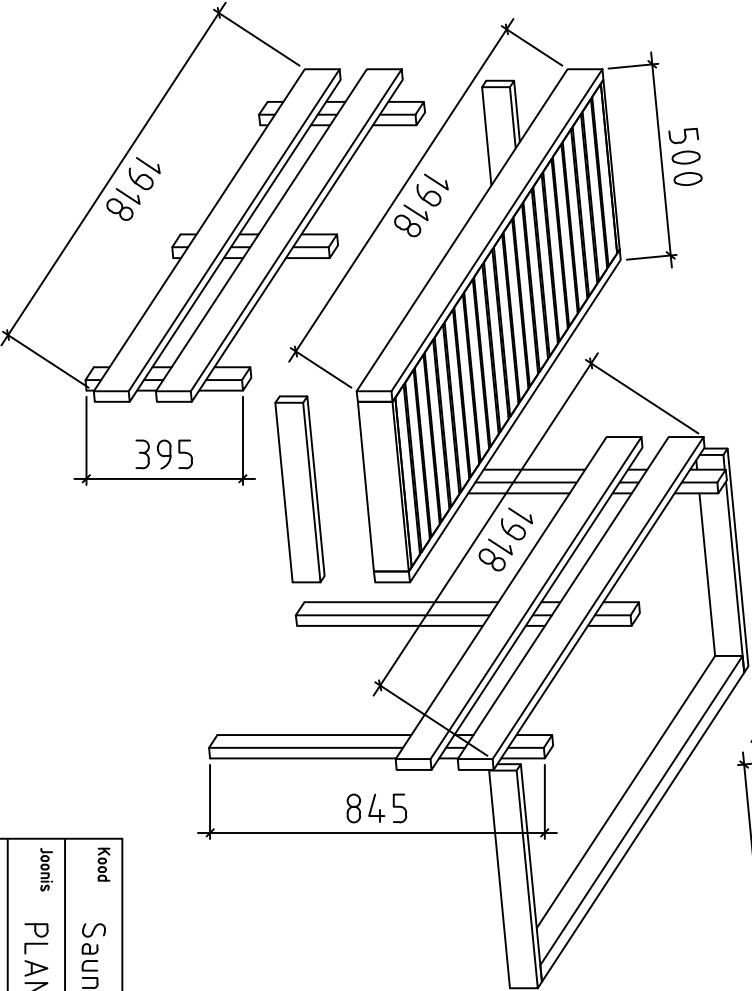
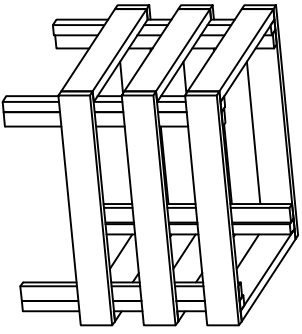

Kood	SaunaNikola40 sisu	Leht
Joonis	PLAN	Moorkava
Materjal	Kaup.	31.01.2022
Joonestas	File	Drawing1.dwg